

2021

News Evolution

by BENEITO FAURE®

We are the evolution of the light.

Beneito Faure's New Home







Beneito Faure presents its new headquarters with over 15,000 square metres distributed among the offices, a warehouse and a new showroom.

Beneito Faure präsentiert seinen neuen Hauptsitz mit mehr als 15.000m². Mit Büros, Lager und einem neuen Ausstellungsraum.

Beneito Faure présente son nouveau siège social avec plus de 15.000m² répartis en bureaux, entrepôt et une nouvelle salle d'exposition.

Beneito Faure presenta la sua nuova sede con oltre 15.000 mq distribuiti tra uffici, un magazzino e un nuovo showroom.

Beneito Faure presenta su nueva sede con más de 15.000m² distribuidos en oficinas, almacén y un nuevo showroom.



These structures host large new spaces that allow a great teamwork and show the growth and development of the company.

—

Die neuen Räumlichkeiten sind auf Teamarbeit ausgerichtet und sollen das Wachstum und den Impuls der Marke repräsentieren.

Ces installations abritent de nouveaux espaces axés sur le travail d'équipe et représentent la croissance et l'impulsion de la marque.

—

Queste strutture ospitano nuovi spazi ampi che consentono il lavoro di squadra e rappresentano la crescita e lo sviluppo dell'azienda.

—

Estas instalaciones albergan nuevos espacios enfocados al trabajo en equipo y representan el crecimiento e impulso de la marca.



EMC Certification / EMC-Zertifizierung / Certification EMC / Certificación EMC / Certificación EMC.



TUYA Technology / TUYA-Technologie / Technologie TUYA / Tecnología TUYA / Tecnología TUYA.



Protection Index / IP-Schutzklasse / Degré de protection IP / Grado di protezione IP / Grado de protección IP.



Color rendering index / Farbwiedergabeindex / Indice de rendu des couleurs / Indice di resa cromatica / Índice de reproducción cromática.



Voltage / Volt / Tension du produit / Voltaggio / Tensión del producto.



Beam Angle / Abstrahlwinkel / Angle d'ouverture / Angolo di apertura / Ángulo de apertura.



Switch Technology / Schaltertechnologie / Technologie Switch / Tecnología Switch / Tecnología Switch.



UGR / Schaltzyklen / UGR / UGR / UGR.

Symbology



Class I / Klasse I / Classe I
/ Classe I / Clase I.



Class II / Klasse II / Classe
II / Classe II / Clase II.



Class III / Klasse III / classe
III / classe III / clase III.



Lifetime / Lebensdauer / Heures de vie /
Durata / Horas de vida.



Warranty / Garantie / Garantie d'années
/ Garanzia / Años de garantía.



Touch control / Berührungssteuerung /
Contrôle tactile / Controllo touch /
Control táctil.



Battery capacity / Batteriekapazität /
Capacité de la batterie / Potenza della
batteria / Capacidad de la batería.



Operating Temperature /
Betriebstemperatur / Température de
travail / Temperatura di lavoro /
Temperatura de trabajo.



IK Rating / IK-Stoßfestigkeitsgrad /
Gamme IK / Grado IK / Rango IK.



Units per box (min-max) /
Verpackungseinheit / Unités par boîte /
Unità per scatola / Unidades por caja.



UV-C Efficacy / UV-C Wirksamkeit /
Efficacité UV-C / Efficacia UV-C / Eficacia
UV-C.



Hertz / Hertz / Hertz / Hertz / Hercios.



Dimmable / Einstellbar / Dimmable /
Dimmerabile / Regulable.



Power Factor / Leistungsfaktor / Facteur
de puissance / Fattore di potenza /
Factor de Potencia.



Recessed Hole / Einbettungsschnitt /
Coupe d'encastrement / Taglio
embedment / Corte de
Empotramiento.



European conformity.



Restriction of Hazardous
Substances.



Electronic waste.

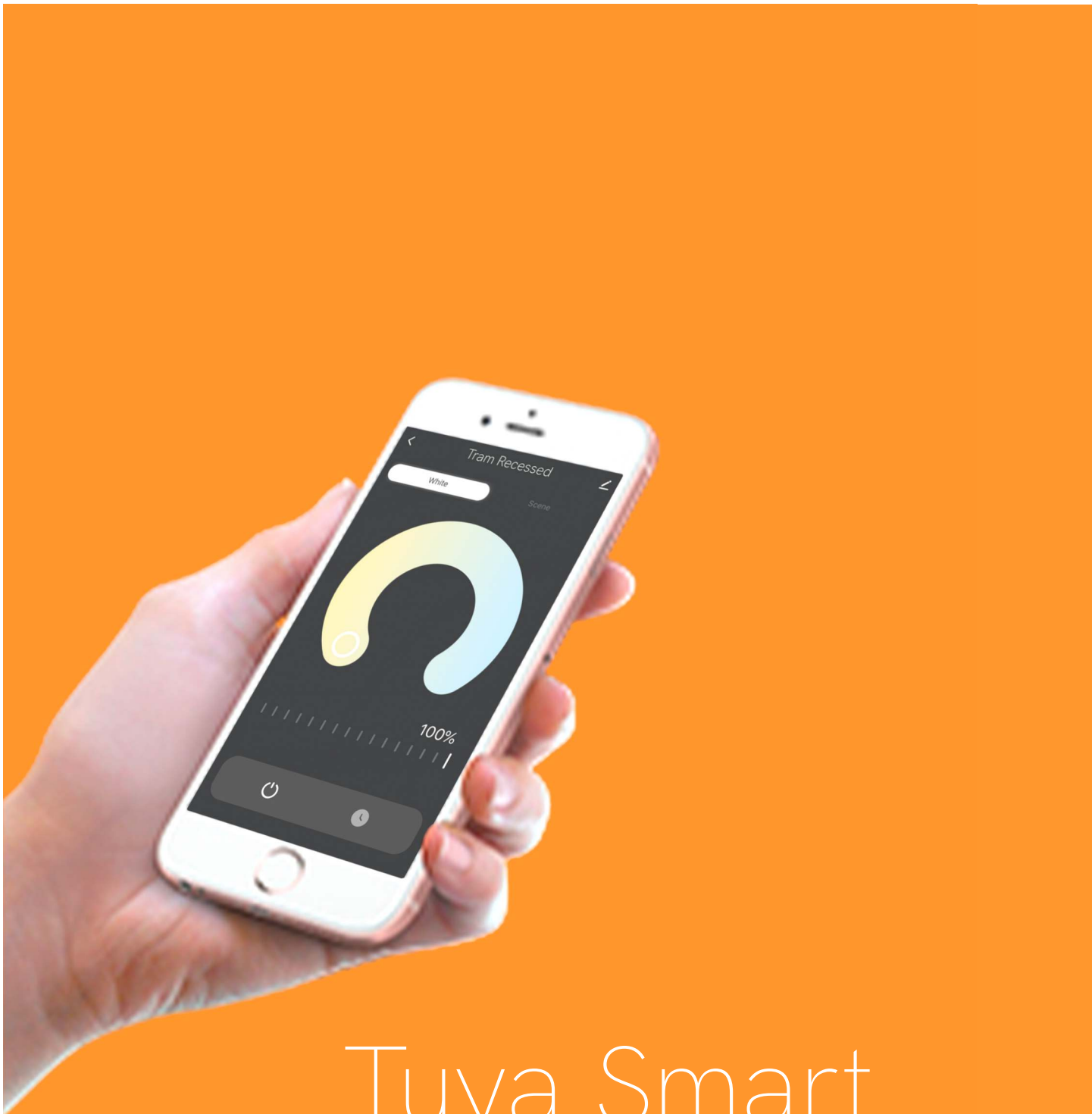

Tuya Smart

For additional information visit
www.beneito-faure.com/tuya



The lighting has never been so intelligent.

Voice control, programming, tone variations, dimmability, on/off switching. Beneito Faure incorporates intelligent lighting in many of its new fixtures this year.

Die Beleuchtung von Beneito Faure war noch nie intelligenter.

Sprachsteuerung, Szeneneinstellung Timerfunktion, Lichtfarbenwechsel, Dimmen, Ein- und Ausschalten sind die neuen Möglichkeiten. Beneito Faure integriert intelligente Beleuchtung in vielen seiner neuen Produkte noch in diesem Jahr.

L'éclairage n'a jamais été aussi intelligent.

Commande vocale, scènes et horaires, changements de tonalité, gradation, marche et arrêt. Beneito Faure intègre un éclairage intelligent dans plusieurs de ses nouveaux produits cette année.

L'illuminazione non è mai stata così intelligente.

Controllo di voce, programmazioni, variazioni di tonalità, dimmerabilità, accensione e spegnimento. Beneito Faure incorpora l'illuminazione intelligente in molte delle sue novità di quest'anno.

La iluminación nunca ha sido más inteligente.

Control de voz, escenas y horarios, cambios de tonalidad, atenuación, encendido y apagado. Beneito Faure incorpora la iluminación inteligente en varias de sus novedades de este año.

Gateway accesories



	Code	Color
Gateway	4956	● White

Projects

Our project department carries out customised lighting solutions following international standards of comfort and visual performance. We work with the most advanced software to offer simulations through 3D rendering and present the best solutions.

Unsere Projektteilung bringt Anwendungskompetenz und Expertenwissen für jede Lichtsituation mit und erstellen das ideale Konzept, nach internationalen Standards, für Ihre Projekte. Wir arbeiten mit der Lichtplanungssoftware Relux, um Simulationen von Kunst- und Tageslicht, 3D-Renderings mit den optimalsten Lösungen anzubieten.

Notre département projets réalise des études d'éclairage personnalisées selon les normes internationales de confort et de performance visuelle. Nous travaillons avec les logiciels les plus avancés afin de proposer des simulations par le biais de rendus 3D et de présenter les meilleures solutions.

Il nostro ufficio progetti realizza studi illuminotecnici personalizzati seguendo standard internazionali di comfort e performance visiva. Lavoriamo con i software più avanzati per offrire simulazioni tramite rendering 3D e presentare le migliori soluzioni.

Nuestro departamento de proyectos realiza estudios de iluminación personalizados siguiendo las normativas internacionales de confort y prestaciones visuales. Trabajamos con el software más avanzado con tal de ofrecer simulaciones a través de renders en 3D y presentar las mejores soluciones.



SALA MARE

SALA MARE





Church Brasov (Romania). Interior Designer: David Raymond. Lighting Designer: Robert Karikas.

NEWS
page 18

PROFILES
page 84

EVOLUTION
page 120



NEWS



Lievo
20



Tram Recessed
24



Sono
28



Atmos Slim
34



Pulcom
38



Bora
44



Zas Square
64



Rok
68



Luk
72



Fenix
80



Top
82



Lievo

Lievo

decorative lighting

Technical Data

Portable lamp with Touch Control and 5200mAh battery.

Light

LED in 3.000K with IP54.

Finishes

White and Matt Black. Aluminium.

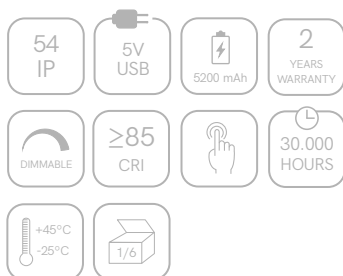
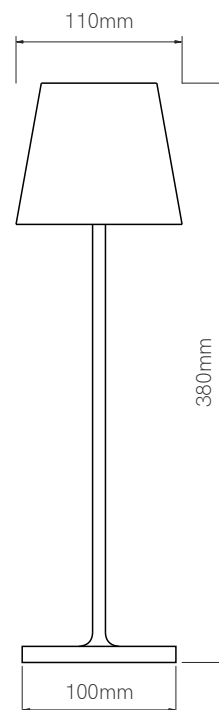
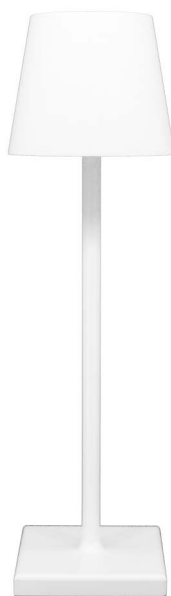

	Code	Color	Power	CCT	Lumens
Lievo	4739	○ White	3,5 W	3.000 K	156 Lm
	4740	● Black	3,5 W	3.000 K	156 Lm





The Wild Bunch, Barcelona (Spain).

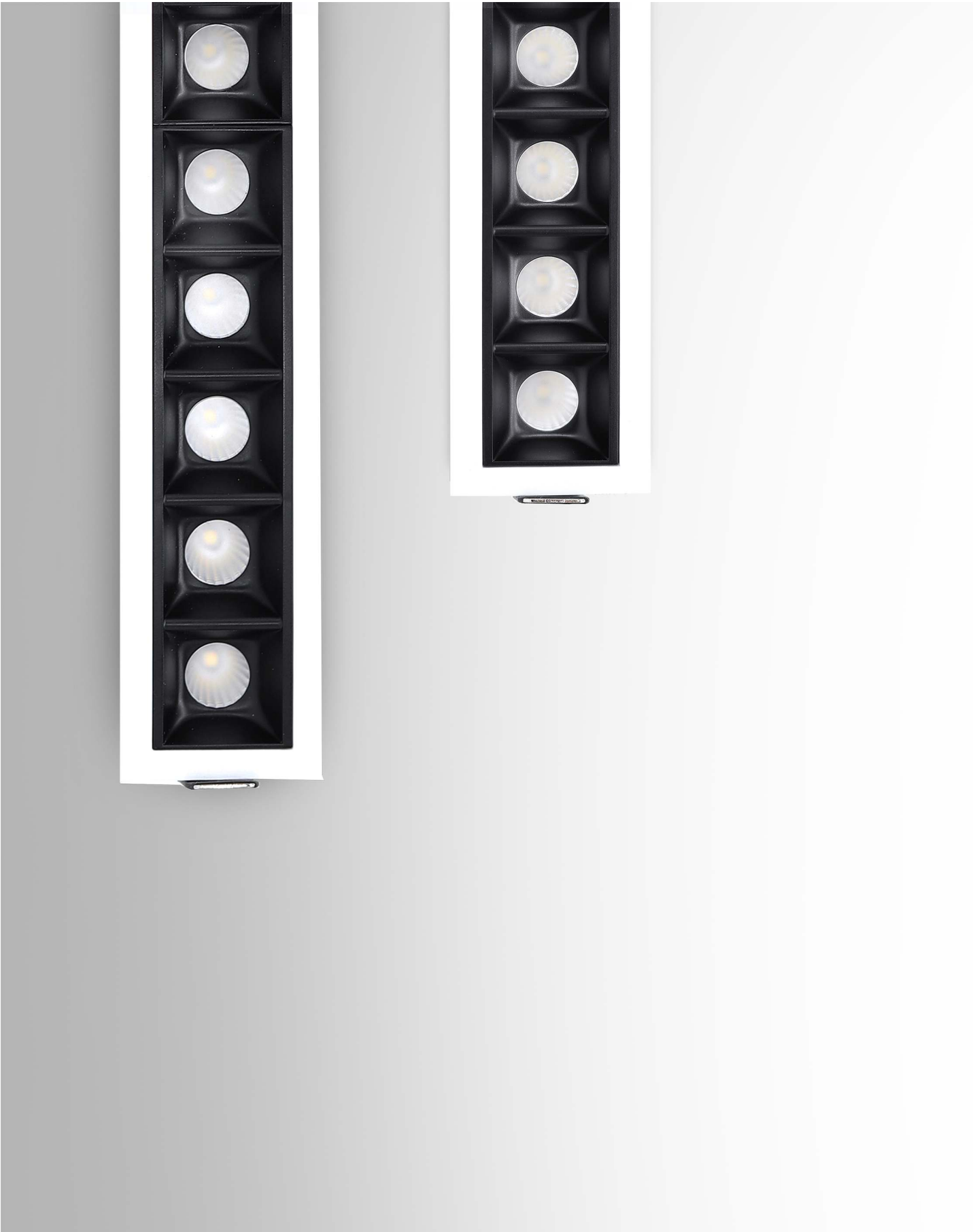

Tram recessed

Tram recessed technical lighting

Technical Data

Combinable fixture with four different power and dimensions with TUYA technology.

Light

LED from 2.700K to 6.000K with CRI>90.

Finishes

White and Matt Black. Aluminium.

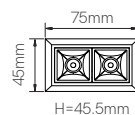

	Code	Color	Power	CCT	Lumens
Tram 2	4731	○ White	6W	2.700K-6.000K	220 Lm
	4732	● Black	6W	2.700K-6.000K	220 Lm

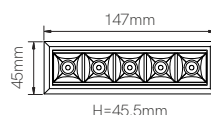
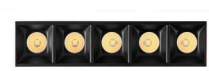

	Code	Color	Power	CCT	Lumens
Tram 5	4733	○ White	10W	2.700K-6.000K	500 Lm
	4734	● Black	10W	2.700K-6.000K	500 Lm

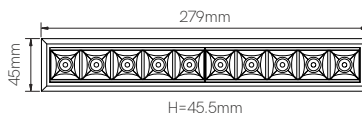

	Code	Color	Power	CCT	Lumens
Tram 10	4735	○ White	20W	2.700K-6.000K	1000 Lm
	4736	● Black	20W	2.700K-6.000K	1000 Lm

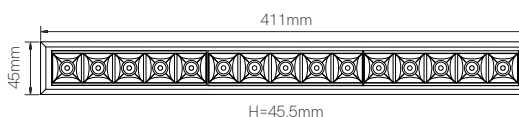

	Code	Color	Power	CCT	Lumens
Tram 15	4737	○ White	30W	2.700K-6.000K	1500 Lm
	4738	● Black	30W	2.700K-6.000K	1500 Lm



20 IP	220/240 VAC	≥90 CRI	UGR <14
50/60 Hz	3 YEARS WARRANTY	30.000 HOURS	30°
IK06	>0,9 PF		+40°C -10°C





Showroom Benito Faure, La Roca del Vallés (Spain).





Sono

Future News

Sono 40W

technical lighting

Technical Data

Square spotlight for three phase track with TUYA technology.

Light

LED from 2.600K to 4.000K with CRI>98.

Finishes

White and Matt Black. Aluminium and Polycarbonate.

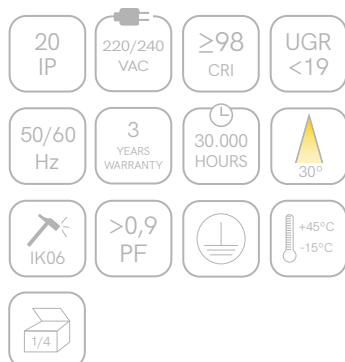
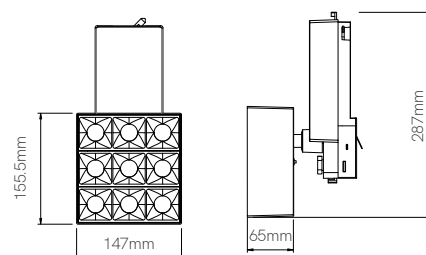

	Code	Color	Power	CCT	Lumens
Sono 40W	4946	○ White	40W	2.600K-4.000K	3130 Lm
	4947	● Black	40W	2.600K-4.000K	3130 Lm



Future News

Sono 60W

technical lighting

Technical Data

Rectangular spotlight for three phase track with TUYA technology.

Light

LED from 2.600K to 4.000K with CRI>98.

Finishes

White and Matt Black. Aluminium and Polycarbonate.

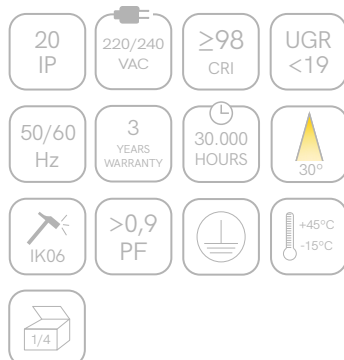
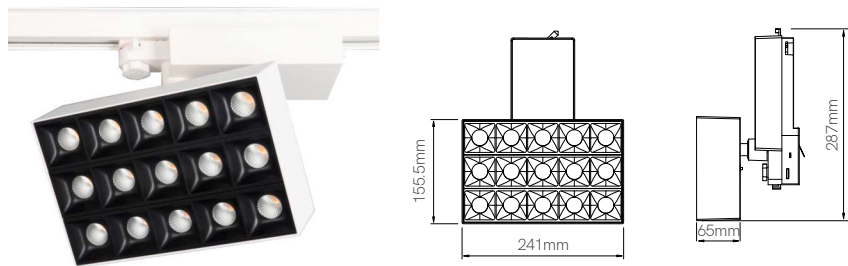

	Code	Color	Power	CCT	Lumens
Sono 60W	4950	○ White	60W	2.600K-4.000K	4390 Lm
	4951	● Black	60W	2.600K-4.000K	4390 Lm



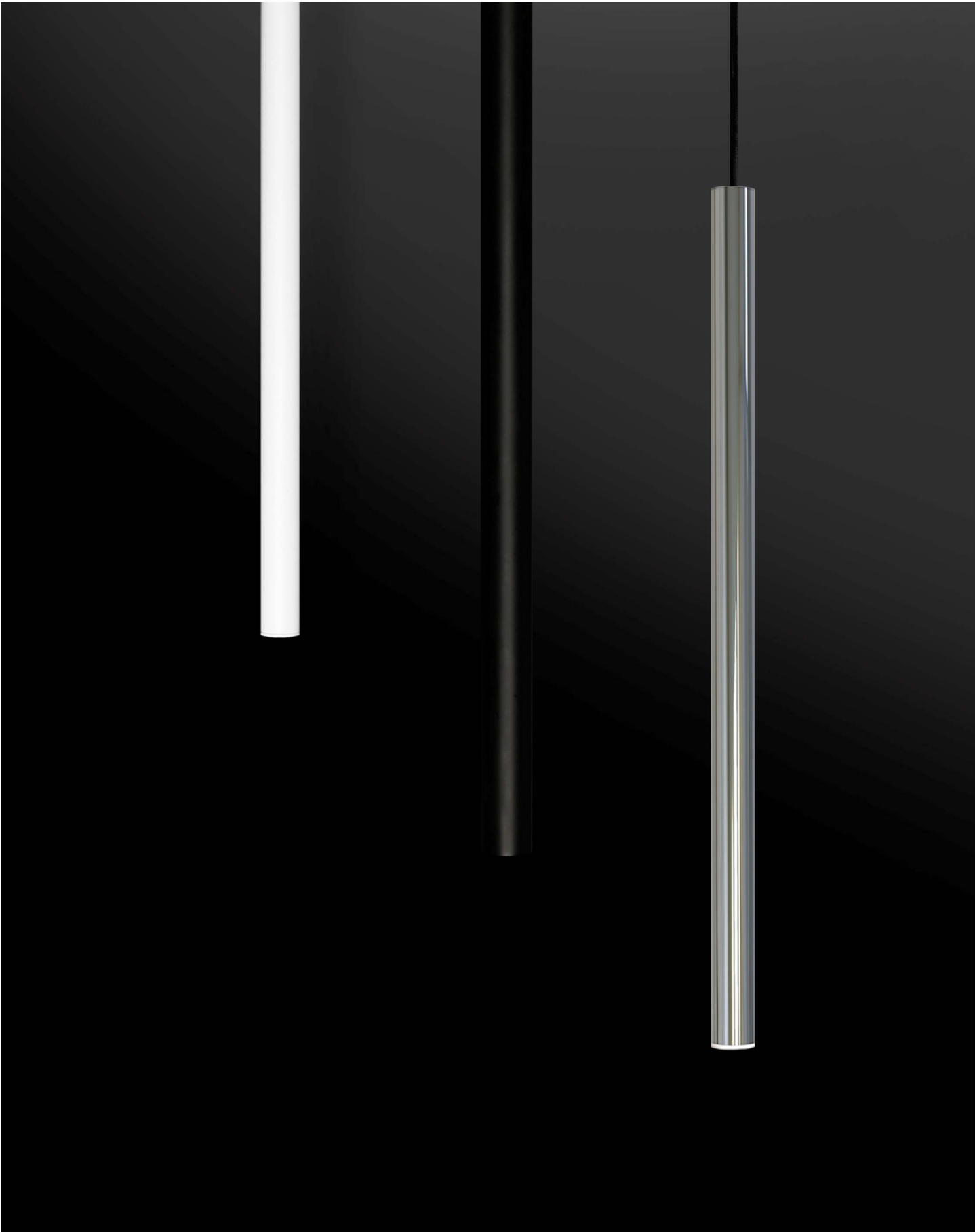

Atmos slim

Atmos Slim

decorative lighting

Technical Data

Luminaire in suspension with a rosette in a recessed or surface mounted version, with 6W of power.

Light

LED from 2.700K to 4.000K with CRI>90.

Finishes

White, matt black and chrome.
Aluminium.

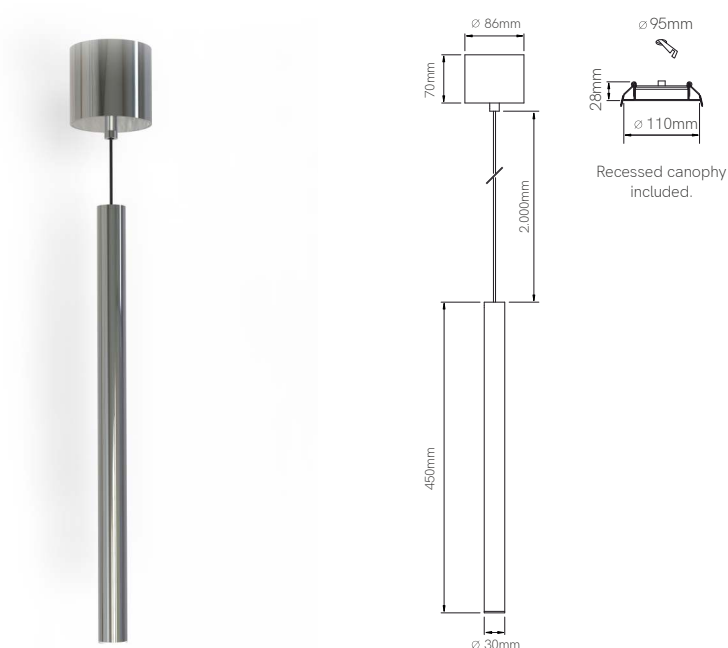

	Code	Color	Power	CCT	Lumens
Atmos Slim 45	4750	○ White	6 W	2.700K-4.000K	460 Lm
	4751	● Black	6 W	2.700K-4.000K	460 Lm
	4752	● Chrome	6 W	2.700K-4.000K	460 Lm





Pulcom

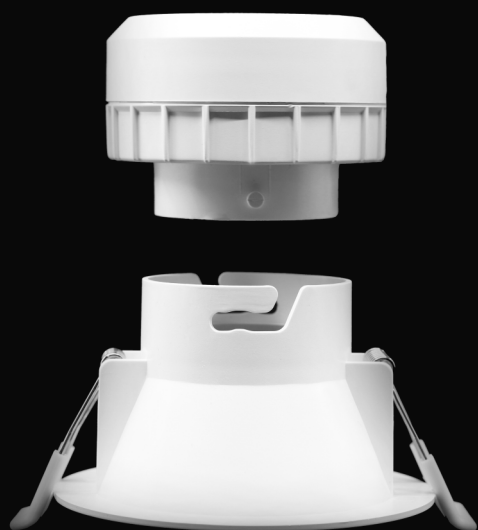

Pulcom

technical lighting

Technical Data
Recessed spotlight.

Light
LED with SWITCH technology in
2.700K/3.200K/4.000K.

Finishes
White and Matt Black. Polycarbonate.

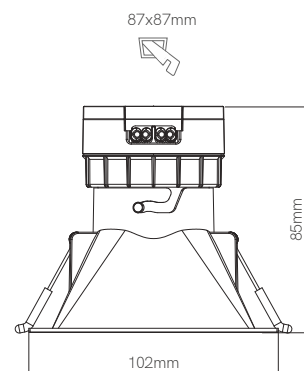

	Code	Color	Power	CCT	Lumens
Pulcom Square	4744	○ White	8 W	2.700K-3.200K-4.000K	800 Lm
	4748	● Black	8 W	2.700K-3.200K-4.000K	800 Lm

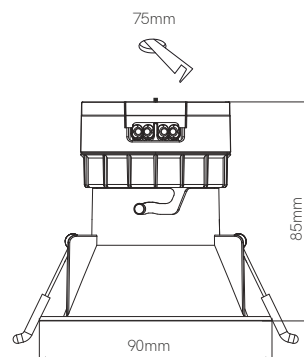

	Code	Color	Power	CCT	Lumens
Pulcom Round	4742	○ White	8 W	2.700K-3.200K-4.000K	800 Lm
	4746	● Black	8 W	2.700K-3.200K-4.000K	800 Lm



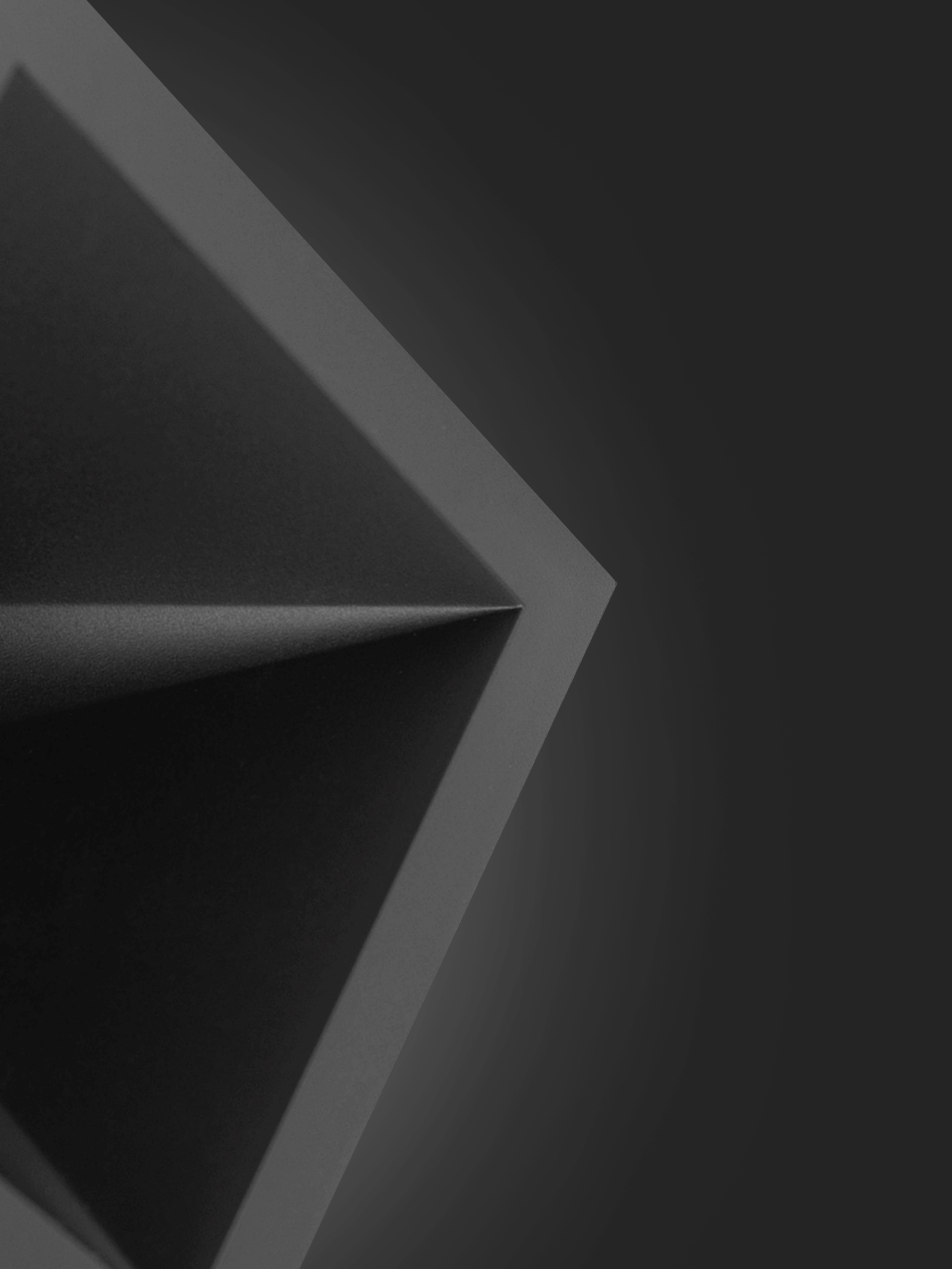

Pulcom asymmetric technical lighting

Technical Data

Asymmetric recessed spotlight.

Light

LED with SWTICH technology in 2.700K/3.200K/4.000K.

Finishes

White and Matt Black. Polycarbonate.

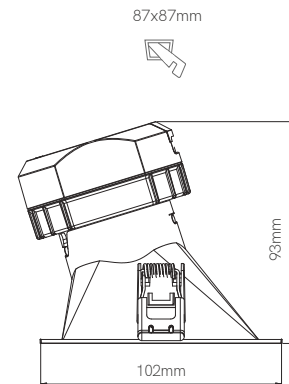

	Code	Color	Power	CCT	Lumens
Pulcom Asymmetrical Square	4745	○ White	8 W	2.700K-3.200K-4.000K	800 Lm
	4749	● Black	8 W	2.700K-3.200K-4.000K	800 Lm

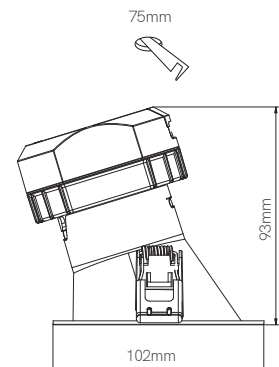

	Code	Color	Power	CCT	Lumens
Pulcom Asymmetrical Round	4743	○ White	8 W	2.700K-3.200K-4.000K	800 Lm
	4747	● Black	8 W	2.700K-3.200K-4.000K	800 Lm

- 44 IP
- 220/240 VAC
- ≥80 CRI
- CCT SWITCH
- 50/60 Hz
- 3 YEARS WARRANTY
- 25.000 HOURS
- 38°
- IK06
- >0,9 PF
-
- +40°C / -20°C
- UGR <19
- 1/5/20









Bora



Meet Bora

The BORA luminaire was born from the idea of creating a minimalist and versatile article that allows it to be placed in multiple positions. During the process of creating the BORA product, it was always kept in mind to create a simple, minimalist but functional product.

Die BORA Leuchtenserie entstand aus der Idee heraus, ein minimalistisches Leuchten System zu schaffen, das variabel und vielseitig einsetzbar ist. Bei der Entwicklung des BORA-Produkts wurde stets daran gedacht, ein einfaches, minimalistisches, aber funktionales Produkt zu produzieren.

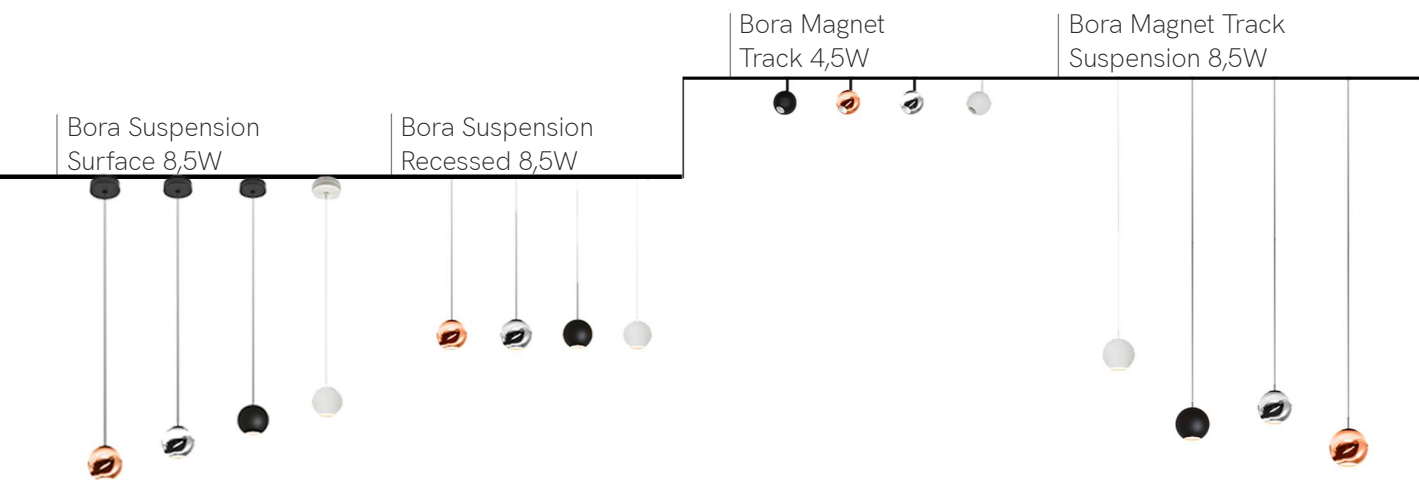

Le luminaire BORA est né de l'idée de créer un article minimaliste et polyvalent, qui permet d'être placé dans de multiples positions. Lors du processus de création du produit BORA, nous avons toujours eu à l'esprit de créer un produit simple, minimaliste mais fonctionnel.

Il prodotto BORA nasce dall'idea di creare un articolo minimalista e versatile che ne consenta l'applicazione in diverse situazioni a seconda delle necessità di posizionamento. Durante la progettazione di questo prodotto si è quindi sempre tenuta in considerazione l'idea di un prodotto semplice, minimalista ma soprattutto funzionale.

La luminaria BORA nasce de la idea de crear un artículo minimalista y versátil, que permite ser colocado en múltiples posiciones. Durante el proceso de creación del producto BORA, siempre se tuvo en mente crear un producto sencillo, minimalista pero funcional.

Bora suspension technical lighting

Technical Data

Suspended decorative fixture.

Light

LED in 2.700K or 3.000K with CRI>93.

Finishes

White, matt black, chrome and rose gold. Aluminium.

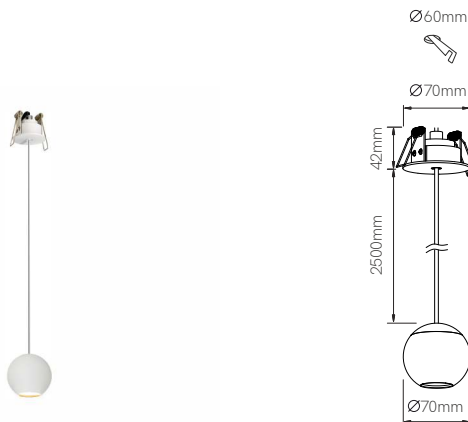

	Code	Color	Power	CCT	Lumens
Bora Suspension Recessed	4613	○ White	8,5 W	2.700 K	530 Lm
	4614	○ White	8,5 W	3.000 K	540 Lm
	4615	● Black	8,5 W	2.700 K	530Lm
	4616	● Black	8,5 W	3.000 K	540Lm
	4617	● Chrome	8,5 W	2.700 K	530 Lm
	4618	● Chrome	8,5 W	3.000 K	540 Lm
	4619	● Rose Gold	8,5 W	2.700 K	530 Lm
	4620	● Rose Gold	8,5 W	3.000 K	540 Lm

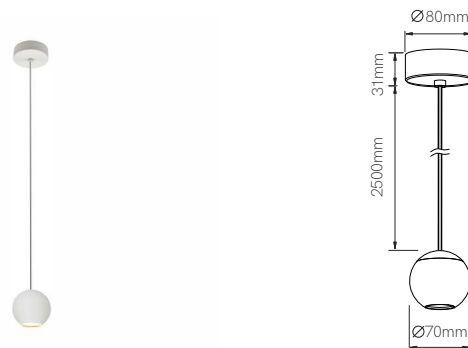

	Code	Color	Power	CCT	Lumens
Bora Suspension Surface	4605	○ White	8,5 W	2.700 K	530 Lm
	4606	○ White	8,5 W	3.000 K	540 Lm
	4607	● Black	8,5 W	2.700 K	530Lm
	4608	● Black	8,5 W	3.000 K	540Lm
	4609	● Chrome	8,5 W	2.700 K	530 Lm
	4610	● Chrome	8,5 W	3.000 K	540 Lm
	4611	● Rose Gold	8,5 W	2.700 K	530 Lm
	4612	● Rose Gold	8,5 W	3.000 K	540 Lm

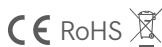
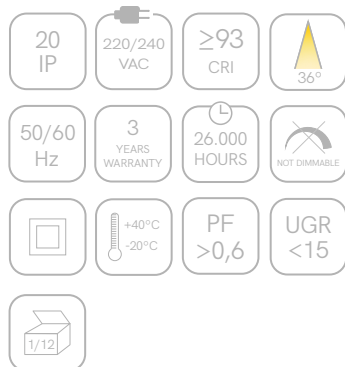



Showroom Beneito Faure, La Roca del Vallés (Spain).

Bora recessed technical lighting

Technical Data

Recessed decorative fixture.





Light

LED in 2.700K or 3.000K with CRI>93.

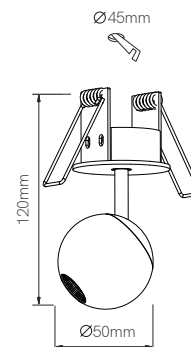



Finishes

White, matt black, chrome and rose gold. Aluminium.

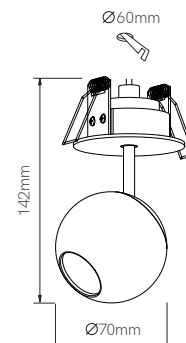

	Code	Color	Power	CCT	Lumens
Bora Recessed 4,5W    	4589	○ White	4,5 W	2.700 K	290 Lm
	4590	○ White	4,5 W	3.000 K	300 Lm
	4591	● Black	4,5 W	2.700 K	290 Lm
	4592	● Black	4,5 W	3.000 K	300 Lm
	4593	● Chrome	4,5 W	2.700 K	290 Lm
	4594	● Chrome	4,5 W	3.000 K	300 Lm
	4595	● Rose Gold	4,5 W	2.700 K	290 Lm
	4596	● Rose Gold	4,5 W	3.000 K	300 Lm



	Code	Color	Power	CCT	Lumens
Bora Recessed 8,5W    	4597	○ White	8,5 W	2.700 K	530 Lm
	4598	○ White	8,5 W	3.000 K	540 Lm
	4599	● Black	8,5 W	2.700 K	530Lm
	4600	● Black	8,5 W	3.000 K	540Lm
	4601	● Chrome	8,5 W	2.700 K	530 Lm
	4602	● Chrome	8,5 W	3.000 K	540 Lm
	4603	● Rose Gold	8,5 W	2.700 K	530 Lm
	4604	● Rose Gold	8,5 W	3.000 K	540 Lm



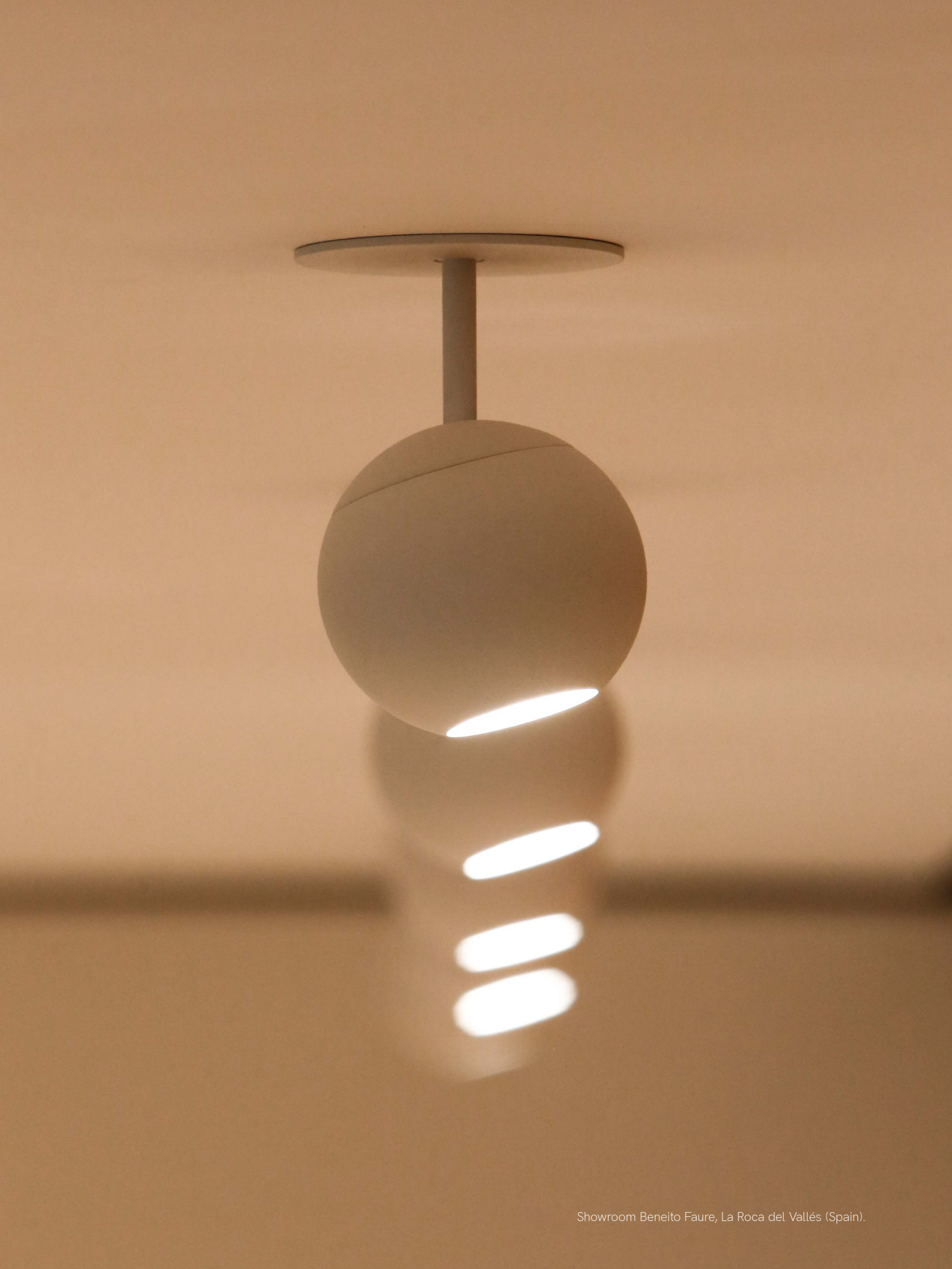

Bora surface technical lighting

Technical Data
Ceiling decorative fixture.

Light
LED in 2.700K or 3.000K with CRI>93.

Finishes
White, matt black, chrome and rose gold. Aluminium.

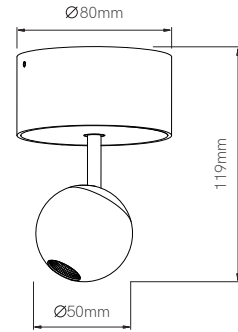

	Code	Color	Power	CCT	Lumens
Bora Surface 4,5W	4621	○ White	4,5 W	2.700 K	290 Lm
	4622	○ White	4,5 W	3.000 K	300 Lm
	4623	● Black	4,5 W	2.700 K	290Lm
	4624	● Black	4,5 W	3.000 K	300Lm
	4625	● Chrome	4,5 W	2.700 K	290 Lm
	4626	● Chrome	4,5 W	3.000 K	300 Lm
	4627	● Rose Gold	4,5 W	2.700 K	290 Lm
	4628	● Rose Gold	4,5 W	3.000 K	300 Lm

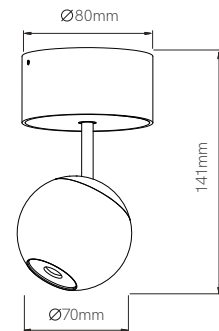

	Code	Color	Power	CCT	Lumens
Bora Surface 8,5W	4629	○ White	8,5 W	2.700 K	530 Lm
	4630	○ White	8,5 W	3.000 K	540 Lm
	4631	● Black	8,5 W	2.700 K	530Lm
	4632	● Black	8,5 W	3.000 K	540Lm
	4633	● Chrome	8,5 W	2.700 K	530 Lm
	4634	● Chrome	8,5 W	3.000 K	540 Lm
	4635	● Rose Gold	8,5 W	2.700 K	530 Lm
	4636	● Rose Gold	8,5 W	3.000 K	540 Lm

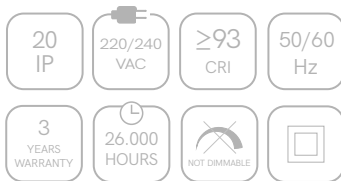





48V magnetic
track





Magnetic Track 48V.

Beneito Faure extends the range of tracks by incorporating the 48V version, available for the BORA family. The use of 48V wall lights provides a more minimalist and elegant lighting effect.

48V Magnetschiene.

Beneito Faure erweitert die Palette der Stromschienen um die 48V-Version, die für die BORA-Familie erhältlich ist. Die Verwendung von 48V-Stromschienen sorgt für ein minimalistisches und elegantes Leuchtenambiente.

Rail magnétique 48V.

Beneito Faure élargit la gamme de rails en y intégrant la version 48V, disponible pour la famille BORA. L'utilisation d'appliques murales en 48V donne un effet de lumière plus minimaliste et plus élégant.

Binario magnetico 48V.

Beneito Faure amplia la gamma dei binari incorporando la versione 48V, disponibile per la famiglia BORA. L'utilizzo di applique a 48V fornisce un effetto di luce più minimalista ed elegante.

Carril Magnético 48V.

Beneito Faure amplía la gama de carriles incorporando la versión de 48V, disponible para la familia BORA. El uso de apliques 48V proporciona un efecto más minimalista y elegante de la luz.

Bora magnet track

technical lighting

Technical Data

Decorative fixture for 48V magnet track.

Light

LED in 2.700K or 3.000K with CRI>93.

Finishes

White, matt black, chrome and rose gold. Aluminium.

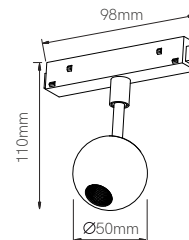

	Code	Color	Power	CCT	Lumens
Bora Magnet Track	4581	○ White	4,5 W	2.700 K	315 Lm
	4582	○ White	4,5 W	3.000 K	325 Lm
	4583	● Black	4,5 W	2.700 K	315 Lm
	4584	● Black	4,5 W	3.000 K	325 Lm
	4585	● Chrome	4,5 W	2.700 K	315 Lm
	4586	● Chrome	4,5 W	3.000 K	325 Lm
	4587	● Rose Gold	4,5 W	2.700 K	315 Lm
	4588	● Rose Gold	4,5 W	3.000 K	325 Lm

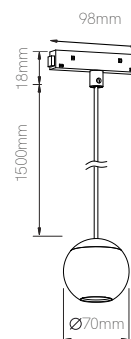

	Code	Color	Power	CCT	Lumens
Bora Magnet Track Suspension	4573	○ White	8,5 W	2.700 K	610 Lm
	4574	○ White	8,5 W	3.000 K	620 Lm
	4575	● Black	8,5 W	2.700 K	610Lm
	4576	● Black	8,5 W	3.000 K	620Lm
	4577	● Chrome	8,5 W	2.700 K	610 Lm
	4578	● Chrome	8,5 W	3.000 K	620 Lm
	4579	● Rose Gold	8,5 W	2.700 K	610 Lm
	4580	● Rose Gold	8,5 W	3.000 K	620 Lm

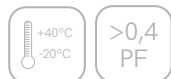



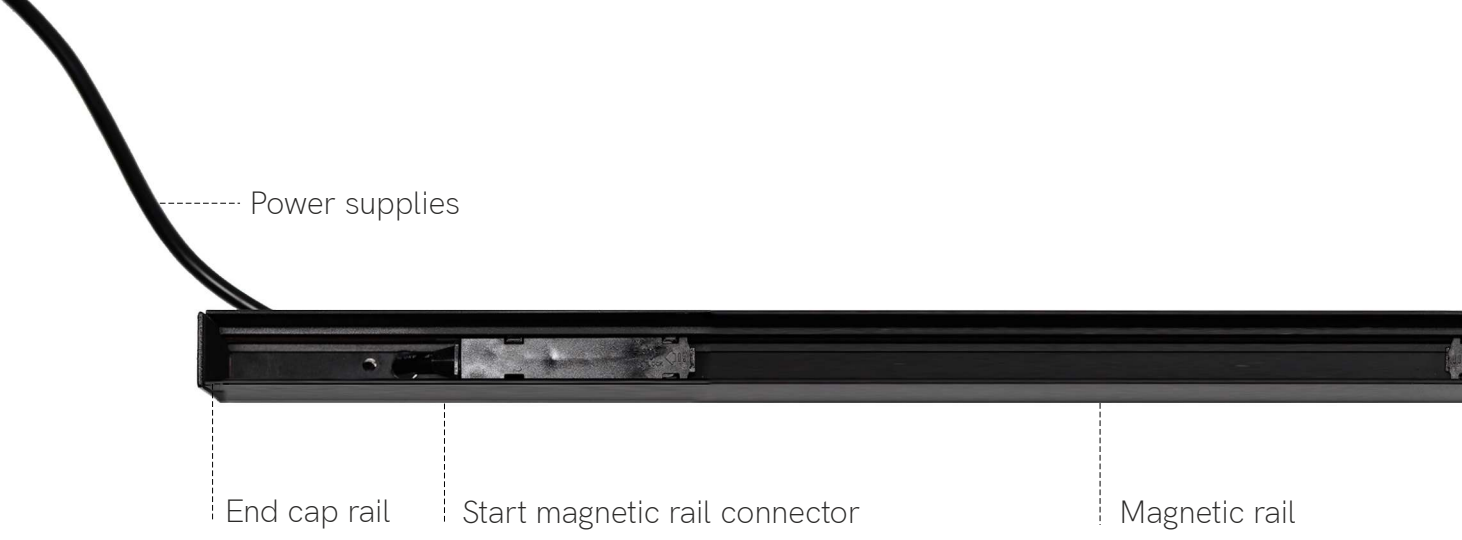

Magnet track recessed accessories

	Code	Color	Meters
	4664	○ White	1m
	4666	○ White	2m
	4663	● Black	1m
	4665	● Black	2m

	Code	Color
	4640	○ White
	4639	● Black

	Code	Color
	4648	○ White
	4647	● Black

	Code	Color
	4655	● Silver

	Code	Color
	4642	○ White
	4641	● Black

Linear joint without spacing

Central corner join with connector

Magnet track surface accessories

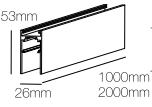
	Code	Color	Meters
Magnetic Rail Surface	4660	○ White	1m
	4662	○ White	2m
	4659	● Black	1m
	4661	● Black	2m

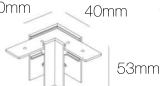
	Code	Color
L-joint Ceiling Surface	4644	○ White
	4643	● Black

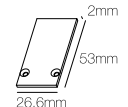
	Code	Color
End cap rail Surface	4650	○ White
	4649	● Black

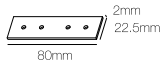
	Code	Color
Linear joint without spacing Surface	4654	○ White
	4653	● Black

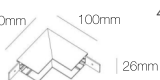
	Code	Color
L-joint Wall Ceiling Surface	4638	○ White
	4637	● Black



Central corner joint with connector



L-joint ceiling

End cap rail

Common accessories

accessories

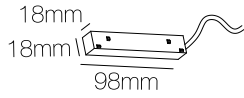

	Code	Color
Start magnetic rail connector	4658	○ White
	4657	● Black

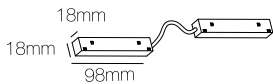

	Code	Color
Central corner joint with connector	4646	○ White
	4645	● Black

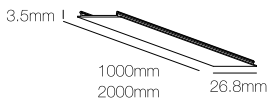

	Code	Color	Meters
Black PVC Trim	4651	● Black	1m
	4652	● Black	2m



Power supplies Basic

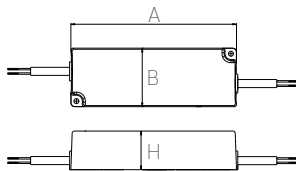

Code	VDC OUT	W	IP	Size (AxBxH)
4711	48 VDC	60W	67	150x53x36mm

Power supplies Top

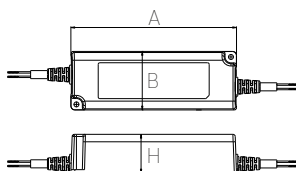

Code	VDC OUT	W	IP	Size (AxBxH)
4707	48 VDC	150W	65	219x63x35mm
4708	48 VDC	240W	65	244x71x37mm





Zas

Zas Square

outdoor lighting

Technical Data

Mini spotlight for outdoor use with IK08.

Light

LED in 3.000K with IP65.

Finishes

White, black and corten. Aluminium.

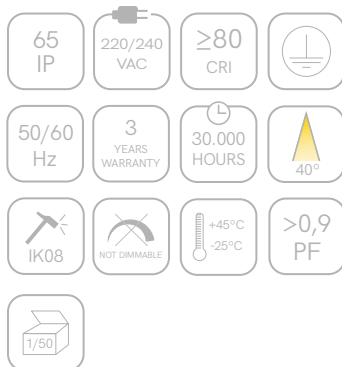

	Code	Color	Power	CCT	Lumens
Zas Square	4690	○ White	7 W	3.000 K	450 Lm
	4692	● Black	7 W	3.000 K	450 Lm
	4693	● Corten	7 W	3.000 K	450 Lm







Rok

Rok rings

Technical Data

Recessed ring for G5.3 bulb.

Light

Bulbholder G5.3 IP65 included.

Finishes

White, Matt Black and brushed chrome. Aluminium.

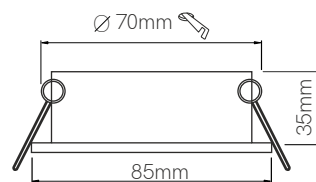

G5.3
12V.

Included.

Recommended
Dichroic: Catalogue
C30



	Code	Color
Rok	4755	○ White
	4756	● Black
	4757	● Brushed







LUK

Luk rings

Technical Data

Recessed ring for GU10 bulb.

Light

Bulbholder GU10 included.

Finishes

White and Matt Black. Aluminium.

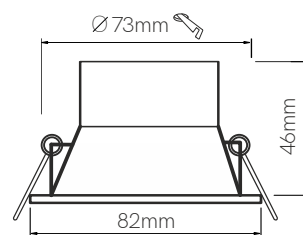

GU10
220V.

Included.

Recommended
Dichroic: Catalogue
C30



	Code	Color
Luk	4758	○ White
	4759	● Black







UV-C LIGHT

UV-C Light.

The UV-C product range has European certification and offers a guaranteed 99.97% efficacy.

UV-C Licht.

Die UV-C-Produktreihe ist in Europa zertifiziert und bietet eine garantierte Wirksamkeit von 99,97%.

Lumière UV-C.

La gamme de produits UV-C est certifiée au niveau européen et offre une efficacité garantie à 99,97 %.

Luce UV-C.

La gamma di prodotti UV-C gode di certificazione europea e offre un'efficacia garantita del 99,97%.

Luz UV-C.

La gama de productos UV-C cuenta con una certificación europea y ofrece un 99.97% de eficacia garantizada.



www.beneito-faure.com



www.beneito-faure.com

Fenix

UV-C

Technical Data

Portable UV-C disinfection wand with 0,7W and 300mAh battery.

Light

Sterilization and disinfection rate 99.97% on any object and surface.

Finishes

White. ABS.

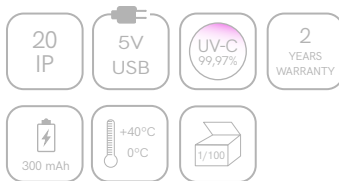
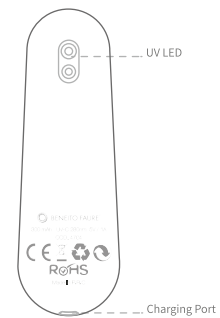
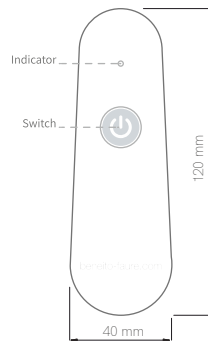

	Code	Color	Power	UV-C	Battery
Fenix	4704	○ White	0,7 W	280nm	300 mAh

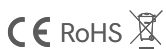

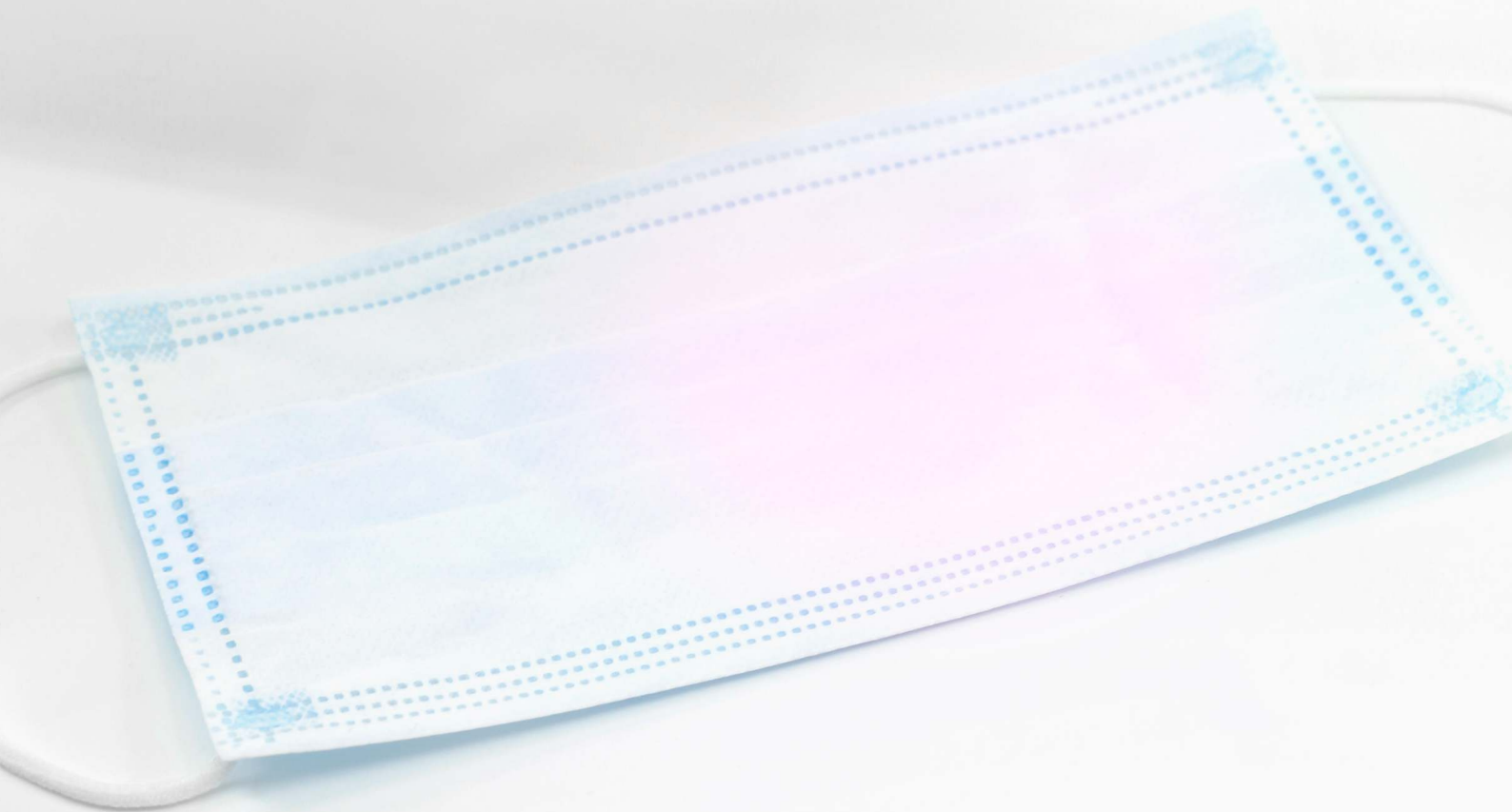

Top

UV-C

Technical Data

Portable UV-C disinfection wand with 2,5W and 600mAh battery.

Light

Sterilization and disinfection rate 99.97% on any object and surface.

Finishes

Matt Black. ABS.

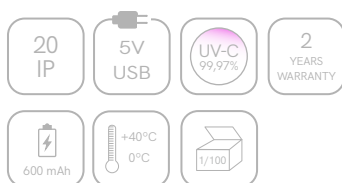
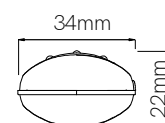
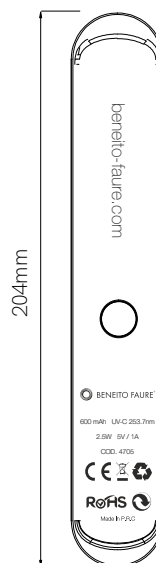
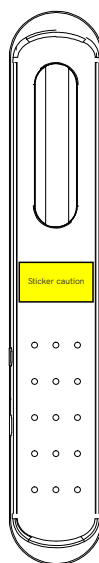

	Code	Color	Power	UV-C	Battery
Top	4705	● Black	2,5 W	253.7nm	600 mAh





PROFILES



Profiles
88



LED Strips
98



Luminaires
110

The custom side of the lighting

We offer a customized and cut-to-measure service adaptable to our clients' needs. Any action is carried out in compliance with the strictest guidelines, as of certifications, efficiency, sustainability and environmentally-friendly.

Wir bieten einen kundenspezifischen und maßgeschneiderten Zuschnitt-Service, der an die Bedürfnisse unserer Kunden angepasst werden kann. Jede Aktion wird unter Einhaltung der strengsten Richtlinien durchgeführt, was Zertifizierungen, Effizienz, Nachhaltigkeit und Umweltfreundlichkeit betrifft.

Nous offrons un service d'exécution et de coupe sur mesure adapté aux besoins de notre client. Tout cela se fait dans le respect des directives les plus strictes en matière de certification, d'efficacité, de durabilité et de respect de l'environnement.

Offriamo un servizio personalizzato e su misura adattabile alle esigenze dei nostri clienti nel rispetto delle linee guida più severe, in termini di certificazioni, efficienza, sostenibilità e rispetto per l'ambiente.

Ofrecemos un servicio de ejecución y corte a medida adecuado a las necesidades de nuestro cliente. Todo ello cumpliendo las directrices más estrictas en aspectos de certificación, eficiencia, sostenibilidad y respeto con el medio ambiente.





Profiles

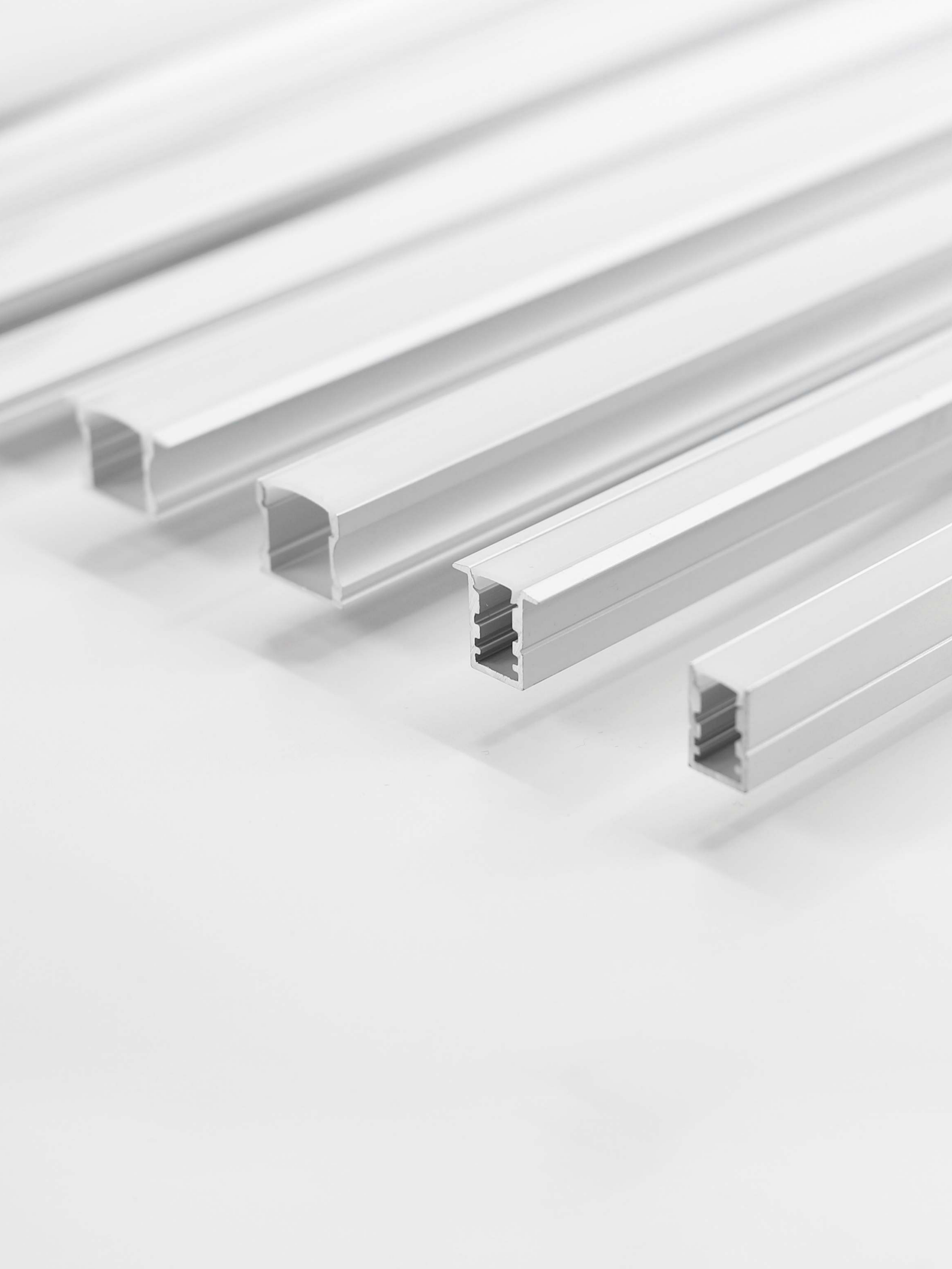



Customized cutting and handling
/ Kundenspezifischer Zuschnitt
und Handling
Maßgeschneiderter / Taglio e
lavorazione su misura /
Découpe et manipulation
personnalisées / Corte y



Made to measure strip LED cutting
/ LED-Streifen-Zuschnitt
Maßgeschneiderte Profillängen /
Taglio della strip LED su misura /
Découpe de bandes de LED à la
taille voulue / Corte de tiras LED a
medida.































































Bespoke finishing /
Kundenspezifische Profil-Farben
/ Finitura personalizzata /
Personnalisation de la peinture /
Personalización de pintura.



Maximum Power / Maximale Leistung / Massima
Potenza / Rendement Maximal / Potencia Máxima



Installation / Installation / Installazione /
Installation / Instalación

Model	Page	Installation	Size	Features
BOX-18	92	 Surface	17,3x14,5 mm	   
BOX-17	92	 Recessed	25x14,5 mm	   
BOX-12	93	 Surface	10x15 mm	   
BOX-11	93	 Recessed	16x15 mm	   
BOX-16	94	 Surface	17,3x7 mm	   
BOX-15	94	 Recessed	17,3x7 mm	   
BOX-14	95	 Surface	16x16 mm	   
BOX-13	95	 Surface	17,9x5,7 mm	   
BOX-19	96	 Surface	25x25 mm	   
BOX-10	96	 Recessed	35x25 mm	   
BOX-35	97	 Surface	35x35 mm	   
BOX-38	97	 Recessed	50x35 mm	   

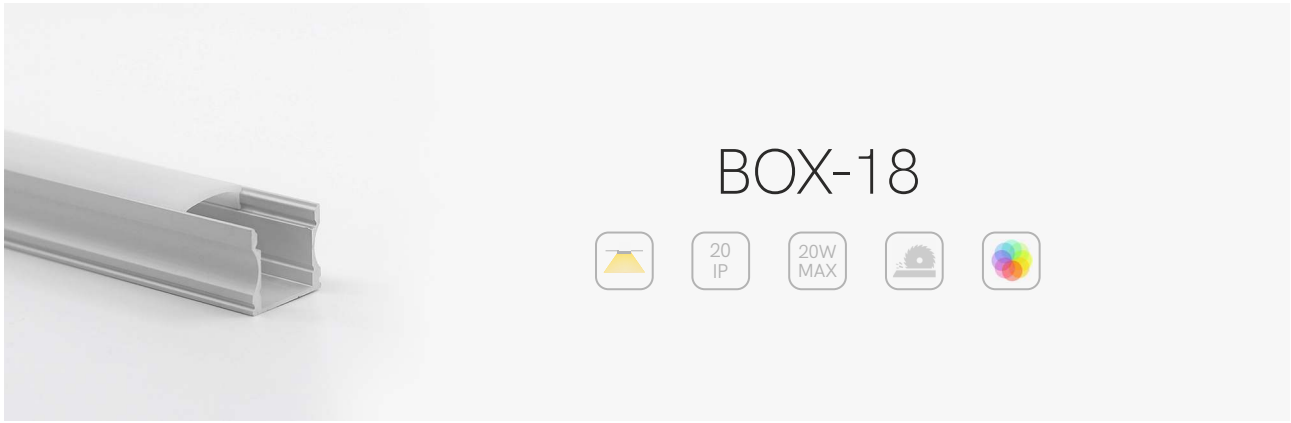

Code	Type	Color	Standard Size
18119	Surface	● Aluminium	2m
18122	Surface	● Black	2m

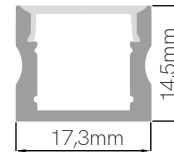

○ Useful area: 12x10mm

Diffusers

- 20440
- 20430
- 20450
- 20472

Accessories

- 18633
- 18632
- 18623
- 18622
- 18653
- 18663
- 20330
- 20350
- 20380

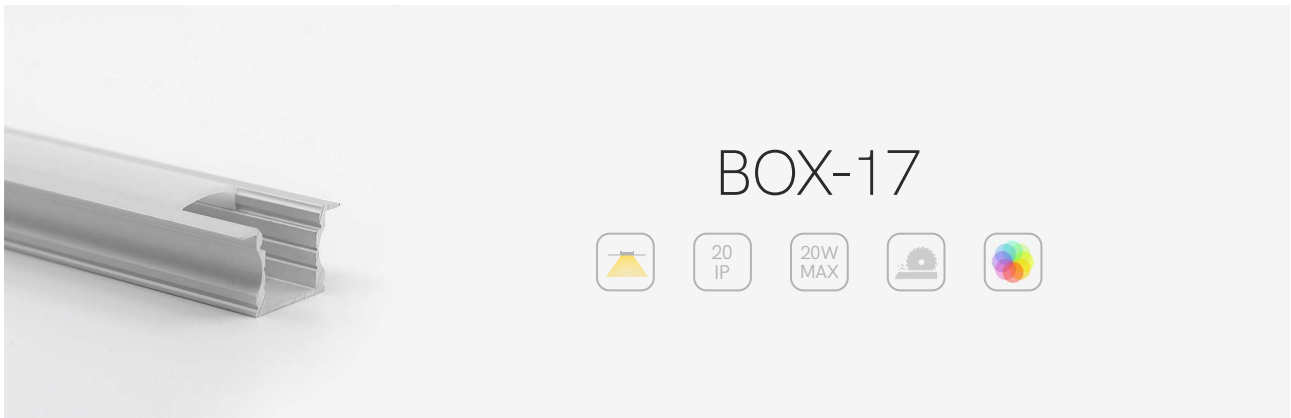

Code	Type	Color	Standard Size
17119	Recessed	● Aluminium	2m
17122	Recessed	● Black	2m

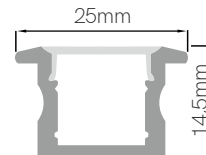

○ Useful area: 12x10mm

➤ 18mmxL

Diffusers

- 20440
- 20450
- 20472

Accessories

- 17633
- 17632
- 17623
- 17622

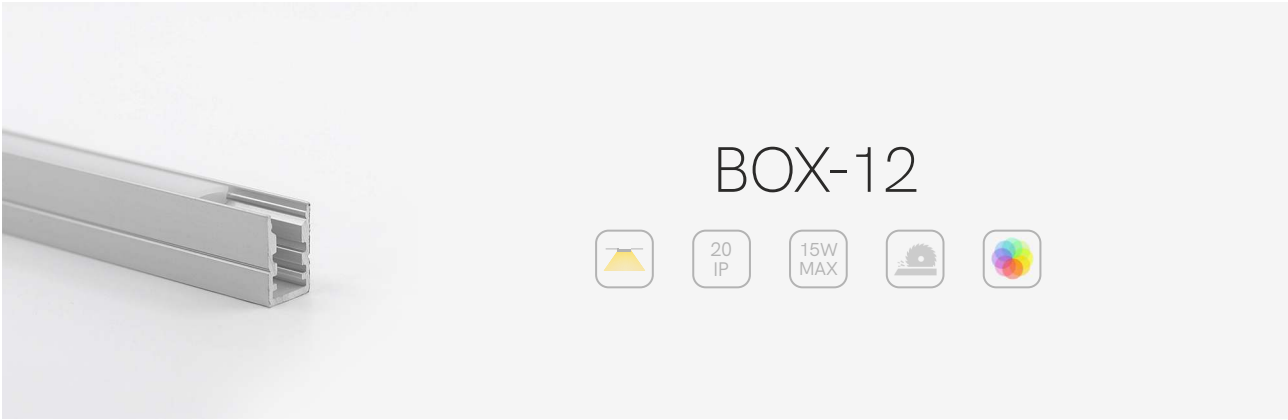

Code	Type	Color	Standard Size
12119	Surface	● Aluminium	2m

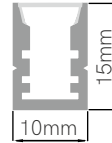

○ Useful area: 5x10mm

Difusers



● 20480

Accessories



● 12633



● 12623



● 20730

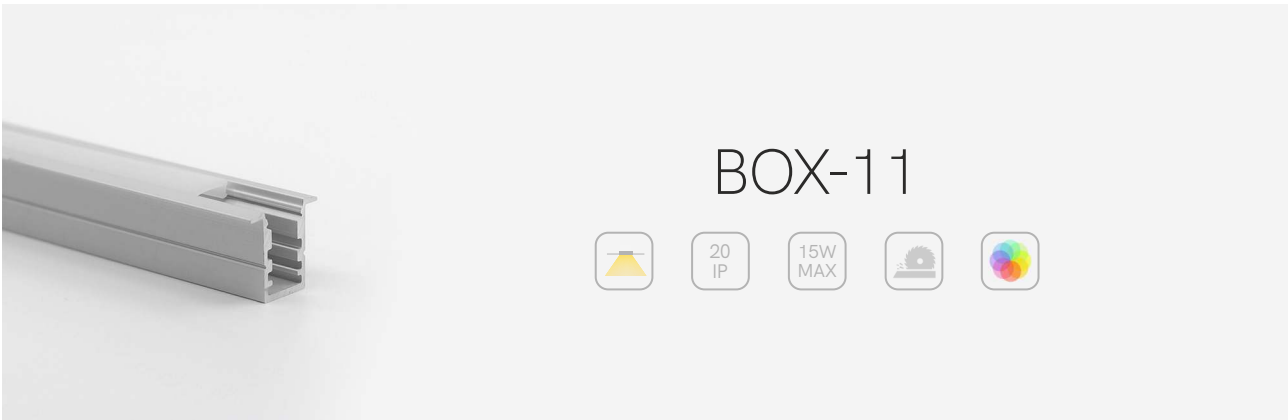

Code	Type	Color	Standard Size
11119	Recessed	● Aluminium	2m

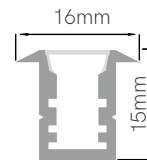

○ Useful area: 5x10mm

🔧 12mmxL

Difusers



● 20480

Accessories



● 11633



● 11623



● 20730

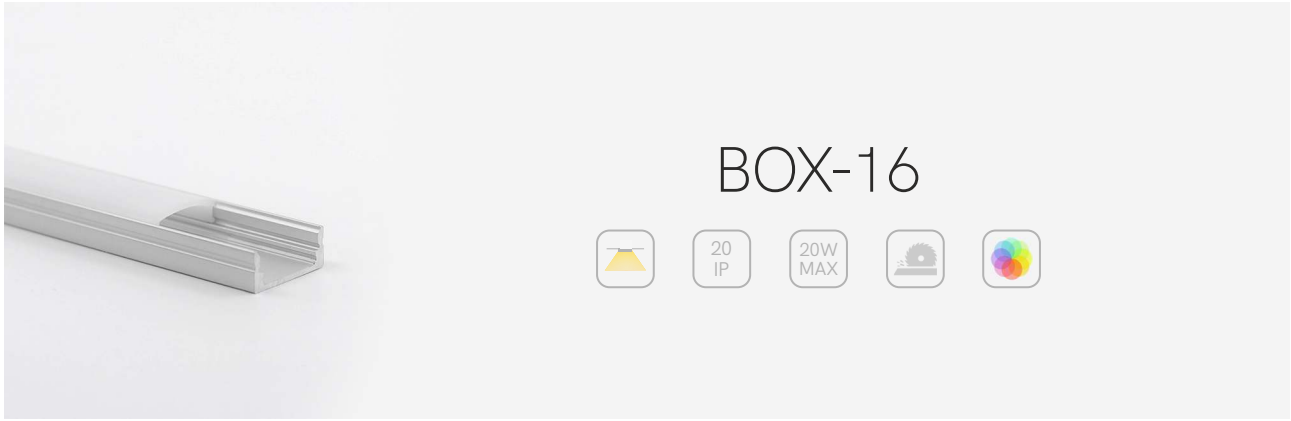

BOX-16



Code	Type	Color	Standard Size
16119	Surface	● Aluminium	2m
16122	Surface	● Black	2m

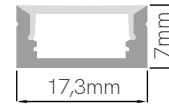

○ Useful area: 12x10mm

Diffusers



- 20440
- 20450
- 20472

Accessories



- 16633
- 16632
- 16623
- 16622
- 20330
- 20350
- 20380

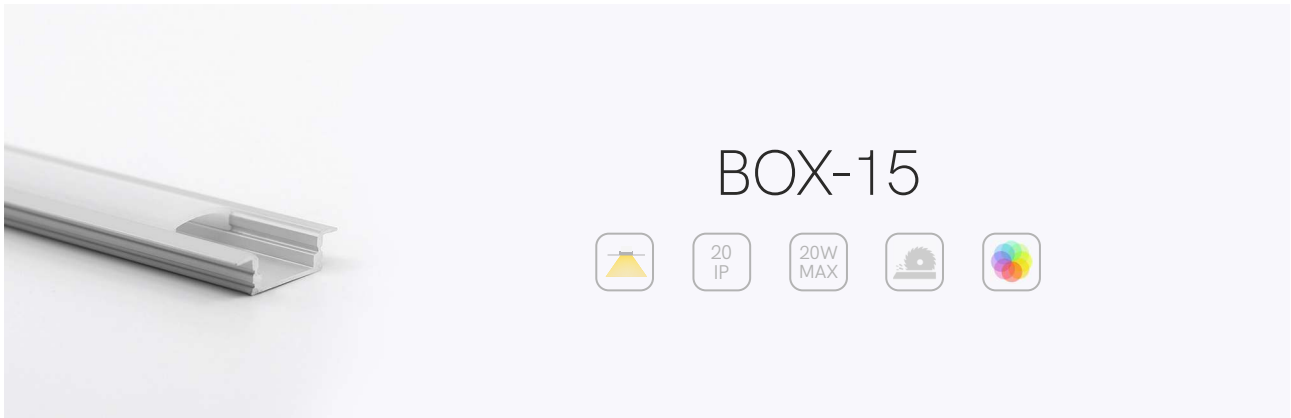

BOX-15



Code	Type	Color	Standard Size
15119	Recessed	● Aluminium	2m
15122	Recessed	● Black	2m

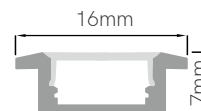

○ Useful area: 12x10mm

✂ 16,5mmxL

Diffusers



- 20440
- 20450
- 20472

Accessories



- 15633
- 15632
- 15623
- 15622

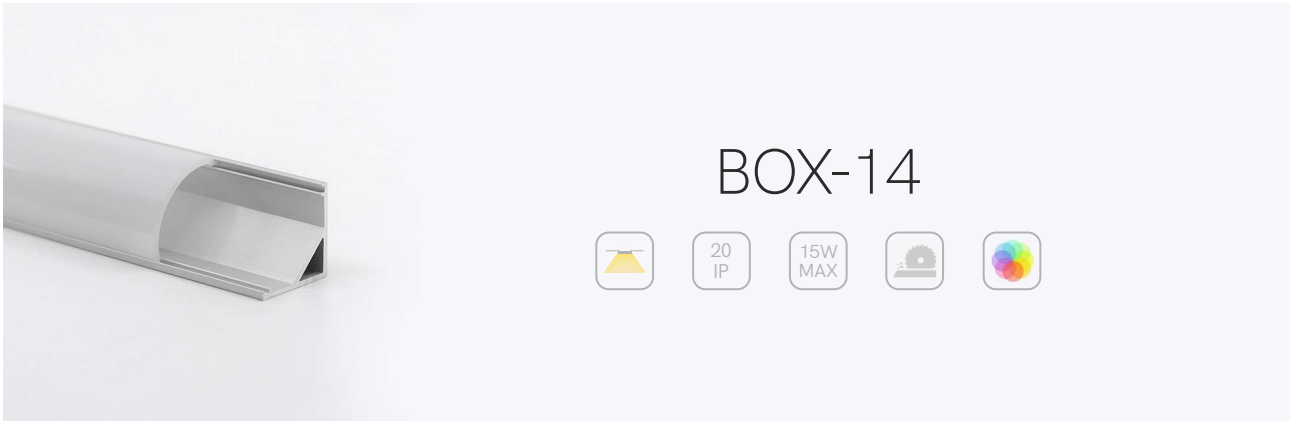

Code	Type	Color	Standard Size
14119	Surface	● Aluminium	2m

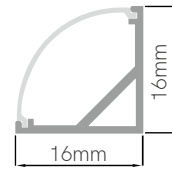

○ Useful area: 10x5mm

Diffusers



● 14480

Accessories



● 14633



● 14623



● 14330

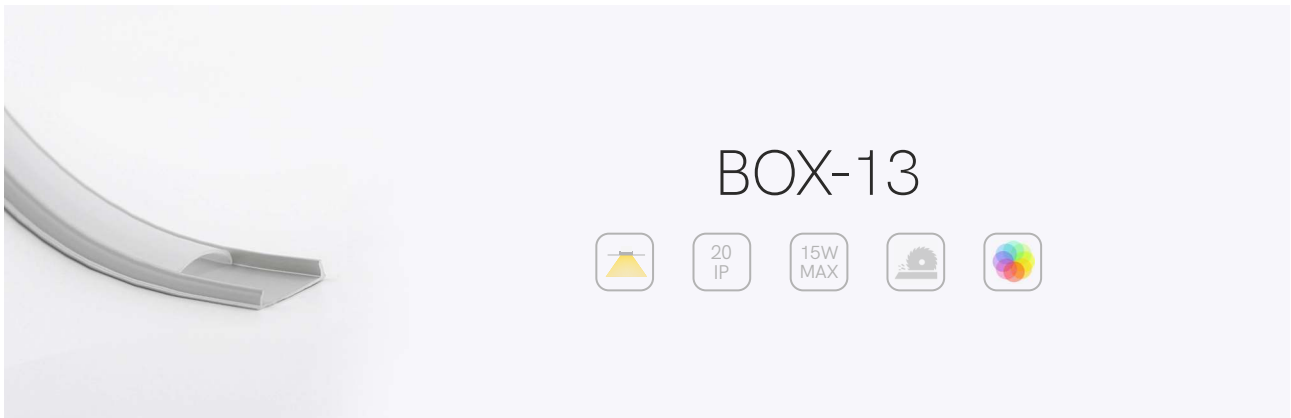

Code	Type	Color	Standard Size
13113	Surface	● Aluminium	2m



○ Useful area: 12x3mm

Diffusers



● 13480

Accessories



● 13633



● 13623



● 13330

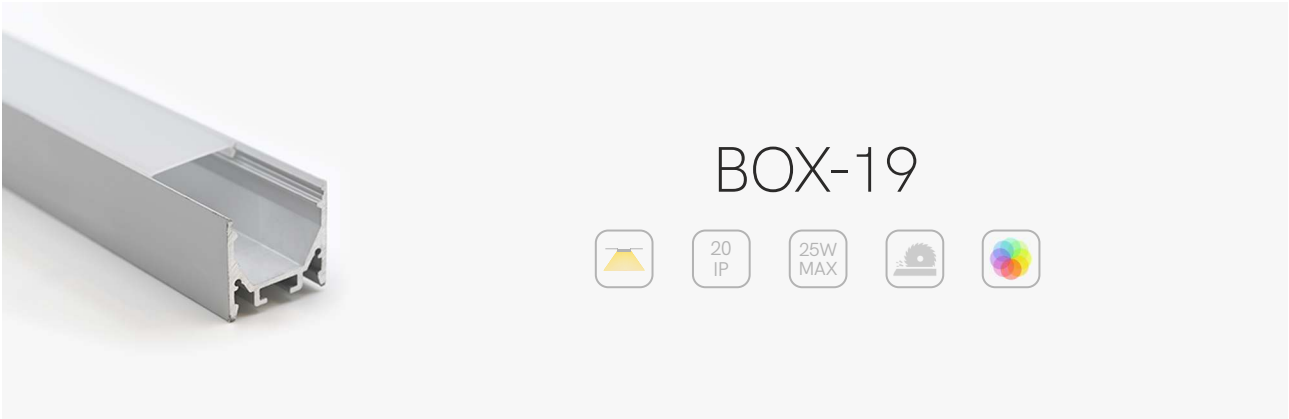

BOX-19

Code	Type	Color	Standard Size
19119	Surface	● Aluminium	2m
19122	Surface	● Black	2m

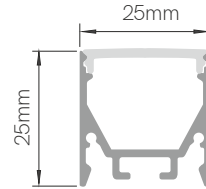

○ Useful area: 13x17.7mm

Diffusers



- 20490
- 20502

Accessories



- 19623
- 19622



- 19330



- 20510



- 20520



- 20720

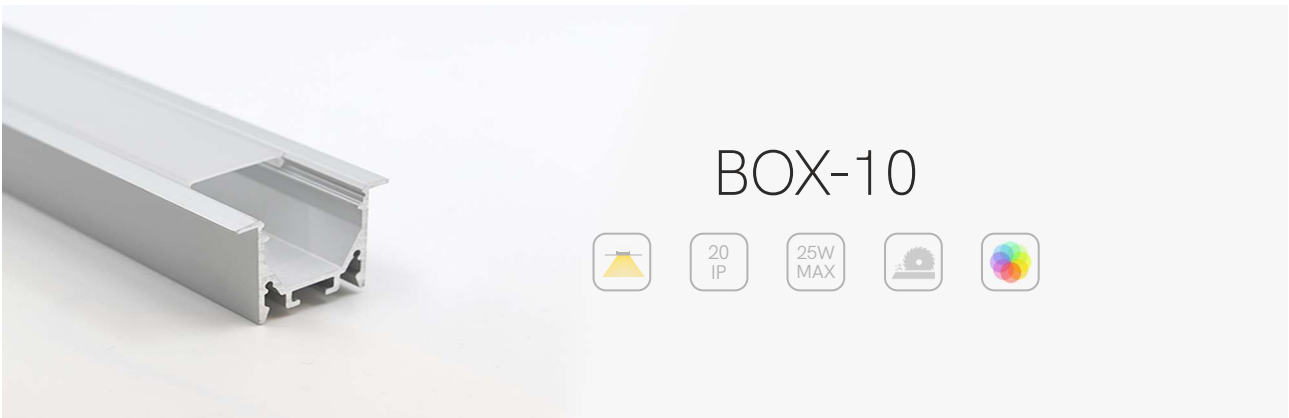

BOX-10

Code	Type	Color	Standard Size
10119	Recessed	● Aluminium	2m
10122	Recessed	● Black	2m

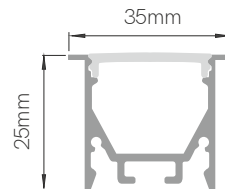

○ Useful area: 13x17.7mm

☞ 22mmxL

Diffusers



- 20490
- 20502

Accessories



- 10633
- 10632



- 10623
- 10622



- 20710



- 20510



- 20520

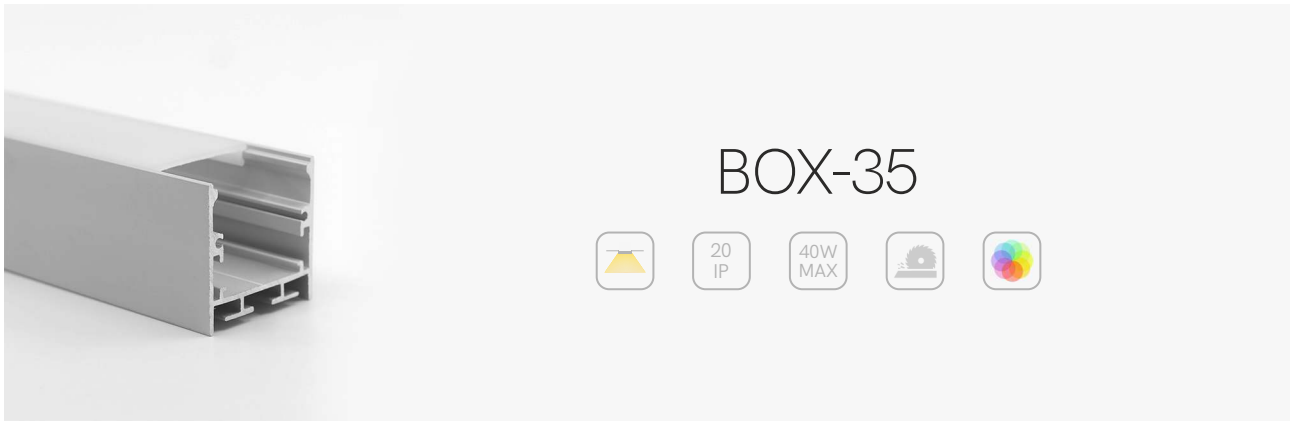

Code	Type	Color	Standard Size
35119	Surface	● Aluminium	2m

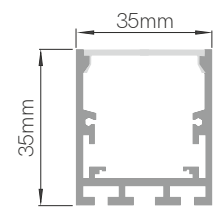

○ Useful area: 25x20mm

Diffusers

Accessories

- 20700
- 35623
- 35330
- 20510
- 20520
- 20720

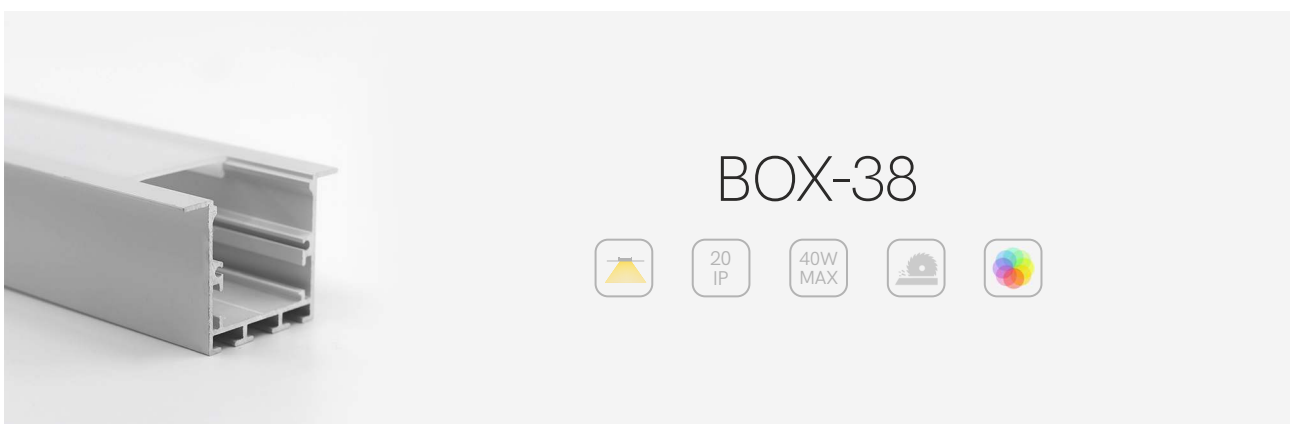

Code	Type	Color	Standard Size
38119	Recessed	● Aluminium	2m

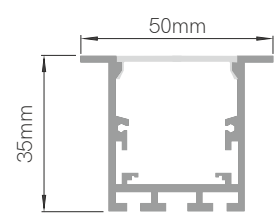

○ Useful area: 25x20mm

➤ 40mmxL

Diffusers

Accessories

- 20700
- 38623
- 20710
- 20510
- 20520

The image features three curved, glowing LED strips arranged in a circular pattern. Each strip is illuminated with a warm, golden-yellow light. On the surface of the strips, there are small orange rectangular markings and text. The text includes '+ DC 3VA' and '-' symbols, indicating electrical connections. The strips are set against a dark, gradient background that transitions from a light grey at the top to a darker grey at the bottom. The overall composition is clean and modern, emphasizing the sleek design and functionality of the LED strips.

LED Strips



Model	Page	W/m	CCT	Width	Features
FINE-31	101	12 W/m	2700K 3000K 4000K	10 mm	Scissors, 20 IP, ≥90 CRI, 24 VDC
FINE-84	101	4,8 W/m	2700K 3000K 4000K 6000K	10 mm	Scissors, 20/65 IP, ≥90 CRI, 24 VDC
FINE-69	102	9,6 W/m	2700K 3000K 4000K 6000K	10 mm	Scissors, 20/65 IP, ≥90 CRI, 24 VDC
FINE-41	102	14,4 W/m	2700K 3000K 4000K 6000K	10 mm	Scissors, 20/65 IP, ≥90 CRI, 24 VDC
FINE-46	103	14,4 W/m	RGB	10 mm	Scissors, 20/65 IP, 24 VDC
FINE-47	103	14,4 W/m	RGB-W	12 mm	Scissors, 20 IP, 24 VDC
FINE-36	104	12 W/m	CCT	10 mm	Scissors, 20 IP, ≥90 CRI, 24 VDC
FINE-49	104	14,4 W/m	2700K 3000K 4000K 6000K	4 mm	Scissors, 20 IP, ≥90 CRI, 24 VDC
FINE-50	105	7,5 W/m	RGB	5 mm	Scissors, 20 IP, 24 VDC
FINE-61	105	16,4 W/m	2700K 3000K 4000K 6000K	10 mm	Scissors, 20 IP, ≥90 CRI, 24 VDC
FINE-52	106	25 W/m	2700K 3000K 4000K 6000K	12 mm	Scissors, 20 IP, ≥90 CRI, 24 VDC
FINE-43	106	16,4 W/m	RGB	12 mm	Scissors, 20 IP, 24 VDC
FINE-32	107	14 W/m	2700K 3000K 4000K 6000K	12 mm	Scissors, 65 IP, ≥80 CRI, 230 VAC



FINE-31

Code	Power	Lm/W	CCT	IP
31270	12W/m	95Lm/W	2700K	20
31300	12W/m	98Lm/W	3000K	20
31400	12W/m	100Lm/W	4000K	20

*Available in reel of 5 meters.

5 YEARS WARRANTY ≥ 90 CRI 24 VDC ✂ 512 LED/m COB

Details

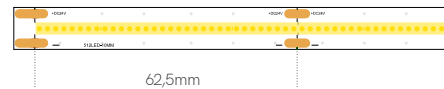

Width = 10mm

High = 1,5mm



FINE-84

Code	Power	Lm/W	CCT	IP
84270	4,8W/m	95Lm/W	2700K	20
84300	4,8W/m	98Lm/W	3000K	20
84400	4,8W/m	100Lm/W	4000K	20
84600	4,8W/m	102Lm/W	6000K	20
84275	4,8W/m	90Lm/W	2700K	65
84305	4,8W/m	92Lm/W	3000K	65
84405	4,8W/m	95Lm/W	4000K	65
84605	4,8W/m	97Lm/W	6000K	65

*Available in reel of 5 or 25 meters.

5 YEARS WARRANTY ≥ 90 CRI 24 VDC ✂ 70 LED/m 2835

Details

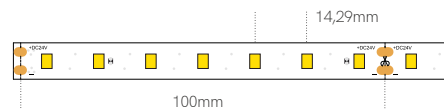

Width = 10mm

High = 1,5mm
3mm



Code	Power	Lm/W	CCT	IP
69270	9,6W/m	95Lm/W	2700K	20
69300	9,6W/m	98Lm/W	3000K	20
69400	9,6W/m	100Lm/W	4000K	20
69600	9,6W/m	102Lm/W	6000K	20
69275	9,6W/m	90Lm/W	2700K	65
69305	9,6W/m	92Lm/W	3000K	65
69405	9,6W/m	95Lm/W	4000K	65
69605	9,6W/m	97Lm/W	6000K	65

*Available in reel of 5 or 25 meters.

5 YEARS WARRANTY ≥90 CRI 24 VDC 140 LED/m 2835

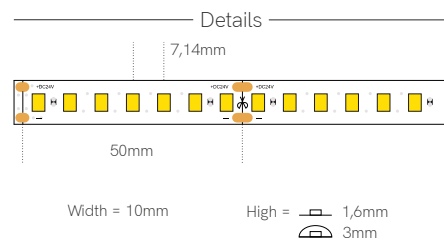

Code	Power	Lm/W	CCT	IP
41270	14,4W/m	95Lm/W	2700K	20
41300	14,4W/m	98Lm/W	3000K	20
41400	14,4W/m	100Lm/W	4000K	20
41600	14,4W/m	102Lm/W	6000K	20
41275	14,4W/m	90Lm/W	2700K	65
41305	14,4W/m	92Lm/W	3000K	65
41405	14,4W/m	95m/W	4000K	65
41605	14,4W/m	97Lm/W	6000K	65

*Available in reel of 5 or 25 meters.

5 YEARS WARRANTY ≥90 CRI 24 VDC 140 LED/m 2835

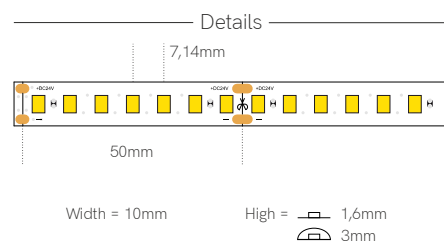

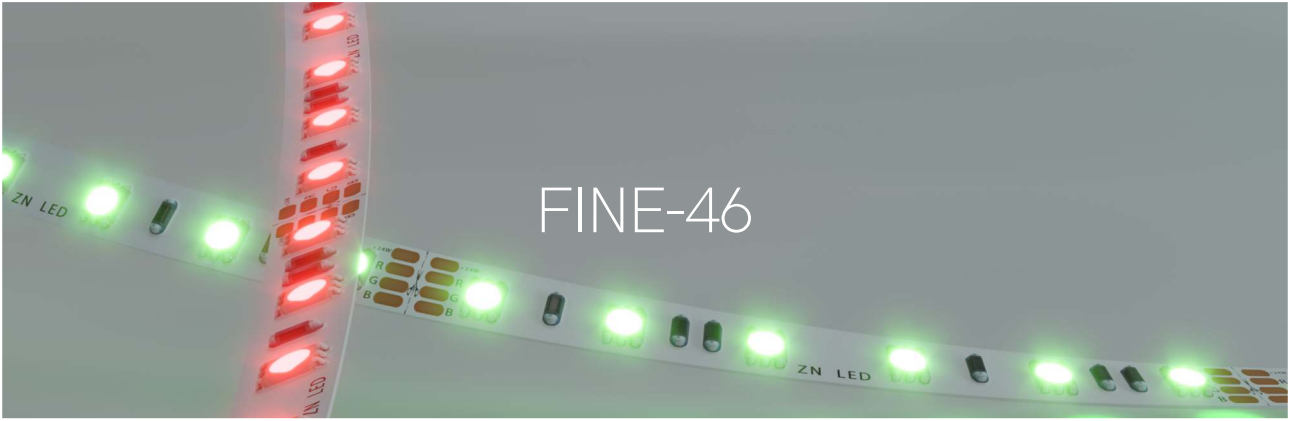

FINE-46

Code	Power	Lm/W	CCT	IP
46460	14W/m	24Lm/W	RGB	20
46465	14W/m	23Lm/W	RGB	65

*Available in reel of 5 or 25 meters.

5 YEARS WARRANTY | 24 VDC | Scissors icon | 60 LED/m | 5050

Details



Width = 10mm

High = 2,2mm
3,2mm



FINE-47

Code	Power	Lm/W	CCT	IP
47430	14,4W/m	47Lm/W	RGB-W	20

*Available in reel of 5 meters.

5 YEARS WARRANTY | 24 VDC | Scissors icon | 60 LED/m | 5050

Details

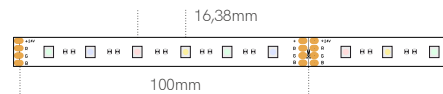

Width = 12mm

High = 2,2mm



Code	Power	Lm/W	CCT	IP
36360	12W/m	100Lm/W	CCT	20

*Available in reel of 5 meters.

-
-
-
-
-
-

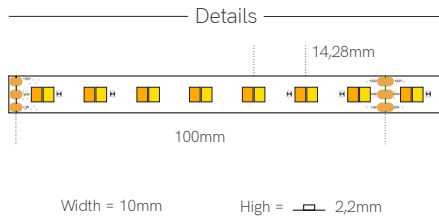

Code	Power	Lm/W	CCT	IP
49270	14,4W/m	71Lm/W	2700K	20
49300	14,4W/m	74Lm/W	3000K	20
49400	14,4W/m	71Lm/W	4000K	20
49600	14,4W/m	74Lm/W	6000K	20

*Available in reel of 5 meters.

-
-
-
-
-
-

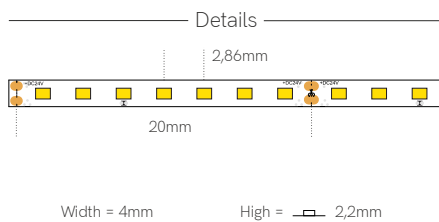

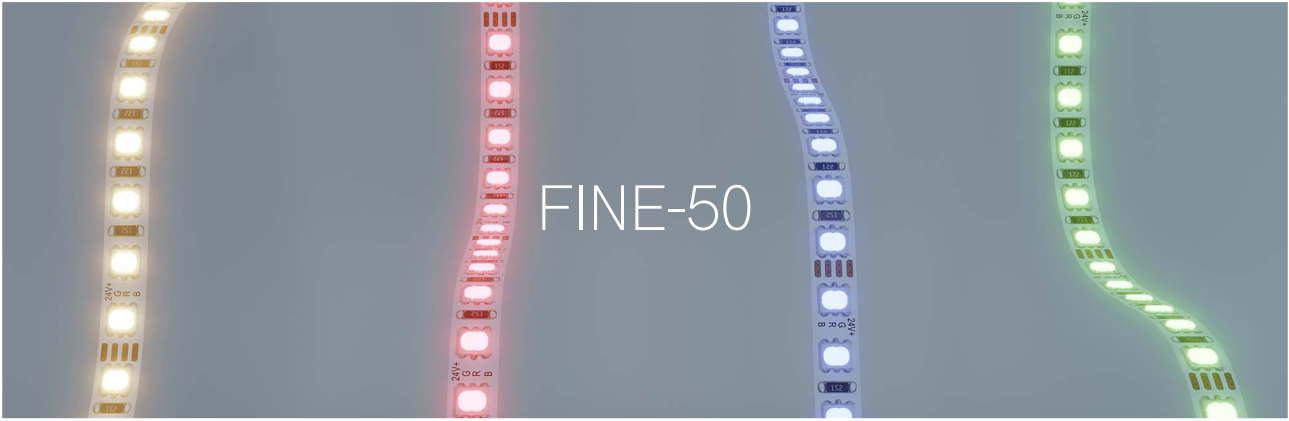

FINE-50

Code	Power	Lm/W	CCT	IP
50460	7,5W/m	39Lm/W	RGB	20

*Available in reel of 5 meters.

3 YEARS WARRANTY
24 VDC
Scissors icon
120 LED/m
3838

Details

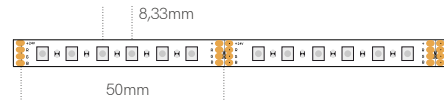

Width = 5mm

High = 2,2mm



FINE-61

Code	Power	Lm/W	CCT	IP
61270	16,4W/m	110Lm/W	2700K	20
61300	16,4W/m	115Lm/W	3000K	20
61400	16,4W/m	120Lm/W	4000K	20
61600	16,4W/m	115Lm/W	6000K	20

*Available in reel of 5 meters.

5 YEARS WARRANTY
≥90 CRI
24 VDC
Scissors icon
160 LED/m
2835

Details

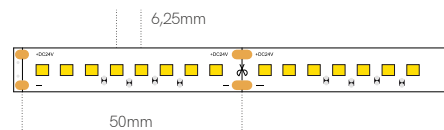

Width = 10mm

High = 1,5mm



FINE-52

Code	Power	Lm/W	CCT	IP
52270	25W/m	109Lm/W	2700K	20
52300	25W/m	115Lm/W	3000K	20
52400	25W/m	120Lm/W	4000K	20
52600	25W/m	115Lm/W	6000K	20

*Available in reel of 5 meters.



Details

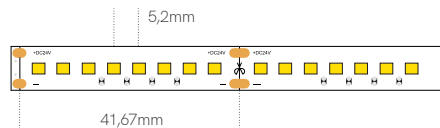

Width = 12mm

High = 1,5mm



FINE-43

Code	Power	Lm/W	CCT	IP
43430	16,4W/m	48Lm/W	RGB	20

*Available in reel of 5 meters.



Details



Width = 12mm

High = 1,5mm



Code	Power	Lm/W	CCT	IP
32275	14W/m	113Lm/W	2700K	65
32305	14W/m	114Lm/W	3000K	65
32405	14W/m	121Lm/W	4000K	65
32605	14W/m	118Lm/W	6000K	65

*Available in reel of 5 or 50 meters.

3
YEARS
WARRANTY

≥80
CRI

230
VAC

✂️

120
LED/m

3528

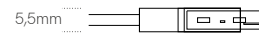
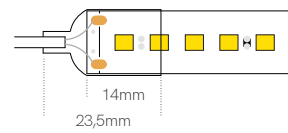
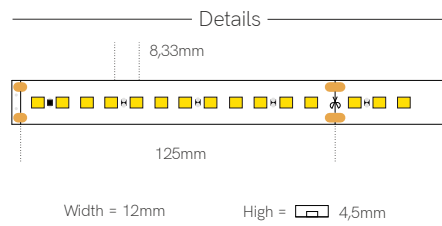

LED Strips accessories

accessories

Control Basic



Description	Code	Amperes	VDC IN	IP	Size
RF Mono Remote	90990	—	5 VDC (3xAAA)	20	120x46x18mm
RF CCT Remote	89260	—	5 VDC (3xAAA)	20	120x46x18mm
RF RGB Remote	88460	—	5 VDC (3xAAA)	20	120x46x18mm
RF RGBW Remote	91430	—	5 VDC (3xAAA)	20	120x46x18mm
Control Mono/CCT/RGB	86019	5Ax3C	12-24 VDC	20	145x46x18mm
Control RGBW	87029	5Ax4C	12-24 VDC	20	145x46x18mm

3
YEARS
WARRANTY

CE RoHS

Control Top



Description	Code	Amperes	VDC IN	IP	Size
RF Mono Remote	81990	—	4.5 VDC (3xAAA)	20	120x55x17mm
RF CCT Remote	80260	—	4.5 VDC (3xAAA)	20	120x55x17mm
RF RGBW Remote	79430	—	4.5 VDC (3xAAA)	20	120x55x17mm
Control Mono/CCT/RGB/RGBW	77019	5Ax4C	12-36 VDC	20	178x46x18mm

3
YEARS
WARRANTY

CE RoHS

LED Strips accessories

accessories

Control Casambi



Code	Color	Size
57241	○ White	90x90x12mm
57242	● Black	90x90x12mm

Code	Power	VDC IN	Size
59249	72-144W	12-24VDC	72.6x30x18mm



Power supplies Basic

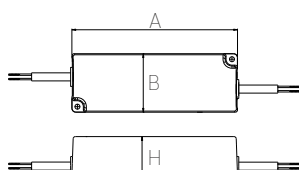

Code	VDC OUT	W	IP	Size (AxBxH)
22420	24 VDC	20W	67	118x35x26mm
22435	24 VDC	36W	67	148x40x30mm
22460	24 VDC	60W	67	162,5x45,5x32mm
22410	24 VDC	100W	67	190x52x37mm
22415	24 VDC	150W	67	191x63x37,5mm

Power supplies Top

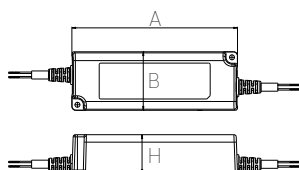

Code	VDC OUT	W	IP	Size (AxBxH)
22424	24 VDC	240W	67	244,2x68x38,8mm
22432	24 VDC	320W	67	252x90x43,8mm



























Luminaires





Incorporates RF command / Enthält den RF-
Befehl / Intègre la commande RF / Incorpora il
comando RF / Incorpora mando RF.

Model	Page	Installation	Size	Features
TIME	114	 Ceiling or Pendant	75x39 mm	  
TIME-E	115	 Recessed	75x54 mm	  
KUBO	116	 Ceiling or Pendant	35x35 mm	  
KUBO-E	117	 Recessed	35x50 mm	  
NEXUS	118	 Pendant	75x39 mm	  
DUAL	119	 Pendant	125x39 mm	  

Time

ceiling or pendant

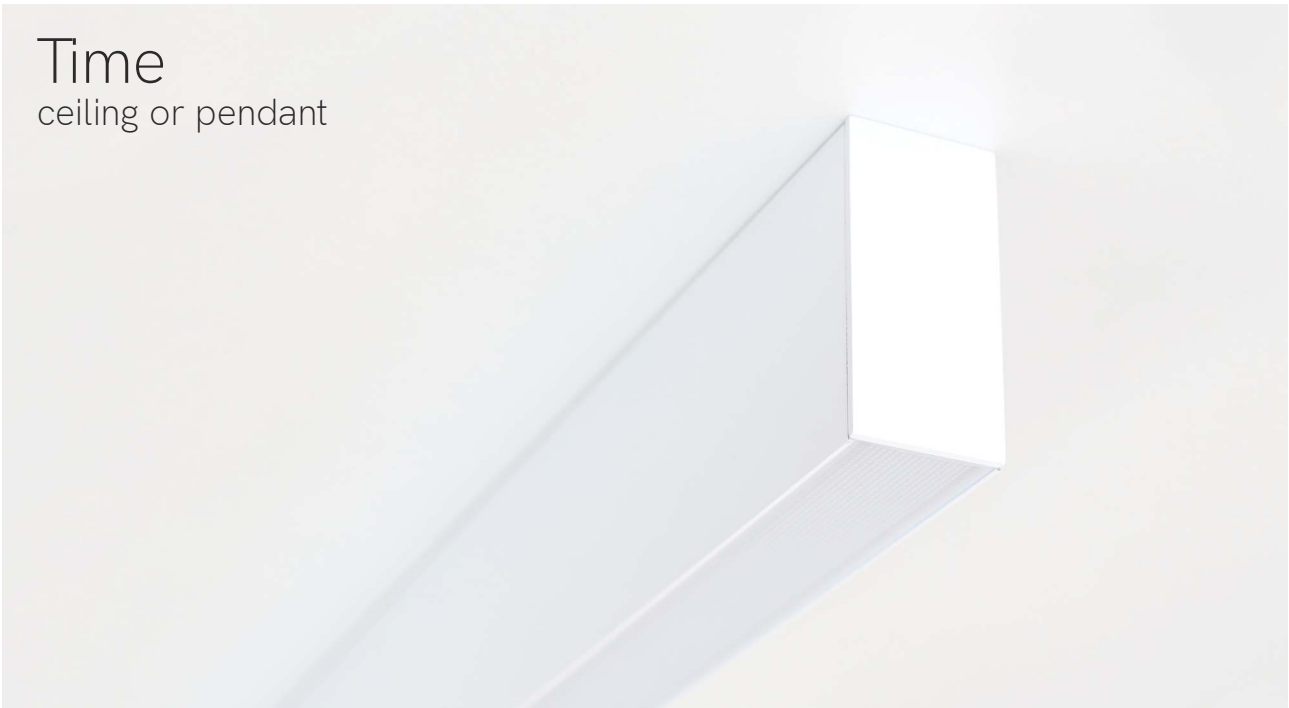

Code	Diffuser	Power - Size	Lm/W - CCT	Driver	Color
8	UGR 3	36W - 1130 mm 3	105 Lm/W - 2700K 2	On/Off 1	White 1
		54W - 1690 mm 5	112 Lm/W - 3000K 3	Dali 2	Black 2
		72W - 2530 mm 7	118 Lm/W - 4000K 4	Push 3	
			118 Lm/W - 5000K 5		
			ⓘ On request		
8 3					

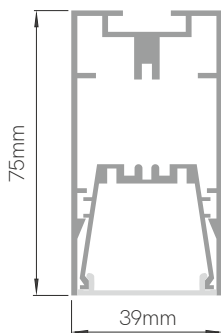

Accessories

○ 40741	● 40770	○ 40881	● 40780	● 40790
● 40742		● 40882		

Customized cutting, handling and bespoke finishing.



Time-E recessed



Code	Diffuser	Power - Size	Lm/W - CCT	Driver	Color
9	UGR 3	36W - 1130 mm 3	105 Lm/W - 2700K 2	On/Off 1	White 1
		54W - 1690 mm 5	112 Lm/W - 3000K 3	Dali 2	Black 2
		72W - 2530 mm 7	118 Lm/W - 4000K 4	Push 3	
			118 Lm/W - 5000K 5		
			⊙ On request		
9 3					

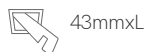
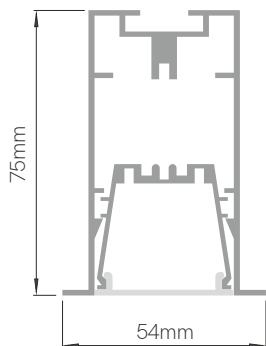

Customized cutting, handling and bespoke finishing.



Kubo

ceiling or pendant



Code	Diffuser	Power - Size	Lm/W - CCT	Driver	Color
7	Opal 5	36W - 1130 mm 3	105 Lm/W - 2700K 2	On/Off 1	White 1
		54W - 1690 mm 5	112 Lm/W - 3000K 3	Dali 2	Black 2
			118 Lm/W - 4000K 4	Push 3	
			118 Lm/W - 5000K 5		

7 5 ■ ■ ■ ■

ⓘ On request

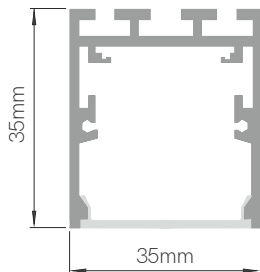

Features

Power supply, suspension kit, power cable and stoppers included in the Kubo box.

Customized cutting, handling and bespoke finishing.



Kubo-E

recessed



Code	Diffuser	Power - Size	Lm/W - CCT	Driver	Color
5	Opal 5	36W - 1130 mm 3	105 Lm/W - 2700K 2	On/Off 1	White 1
		54W - 1690 mm 5	112 Lm/W - 3000K 3	Dali 2	Black 2
			118 Lm/W - 4000K 4	Push 3	
			118 Lm/W - 5000K 5		
					⊙ On request

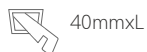
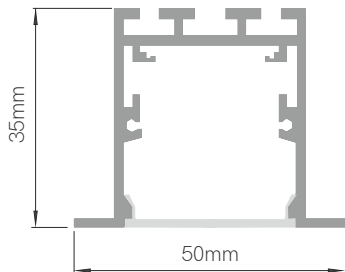

Features

Power supply, clamping claws, power cord and stoppers included in the Kubo-E box.

Customized cutting, handling and bespoke finishing.

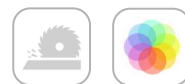

Nexus pendant



Code	Diffuser	Power - Size	Lm/W	CCT	Driver	Color
4	UGR 4	40W - 1130 mm 60W - 1690 mm	3 5	105 Lm/W - 2700-5000K	9	White 1 Black 2
			4 4	9 9		

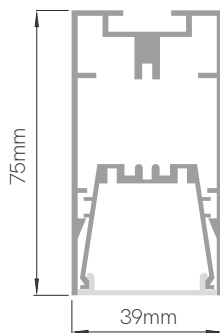

Features

Suspension kit, power cable and stoppers included in the Nexus box.

Customized cutting, handling and bespoke finishing.



Dual pendant



Code	Diffuser	Up/Down - Size	Lm/W - CCT	Driver	Color
5	Opal/UGR 6	24W/28W - 1130 mm 3	105 Lm/W - 2700K 2	On/Off 1	White 1
		36W/42W - 1690 mm 5	112 Lm/W - 3000K 3	Dali 2	Black 2
		48W/56W - 2530 mm 7	118 Lm/W - 4000K 4	Push 3	
			118 Lm/W - 5000K 5		

5 6 ■ ■ ■ ■

⊙ On request

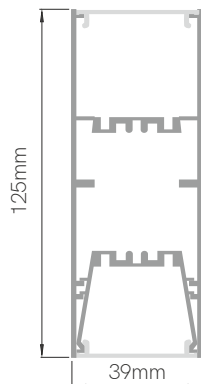

Features

Suspension kit, power cable and stoppers included in the Dual box.

Customized cutting, handling and bespoke finishing.



EVOL UTION



Three phase recessed track

124



Konic

125

Kom

126



Nox

128



Pure

129



Atmos

130



Atmos GU10

132



Concord

134



Rubyc

135



Thesis Dimmable

136



Cam 60cm

138



Selen

140



Zibor

141



Sky 10W Switch

142



Sky 20W Switch

143



Sky 30W Switch

144



Sky 40W Switch

145



Globo

146



Narrow Dimmable

147



The Evolution of the light



The evolution is essential to achieve a quality product. The Switch technology, high- ranking CRI or new finishes belong to the built-in references.

Die Weiterentwicklung von Produkten ist entscheidend, um ein Qualitätsprodukt zu entwickeln. Die Switch-Technologie, hohe CRI - Werte oder neue Oberflächen gehören zur technologischen Weiterentwicklung unserer Produkte.

L'évolution est d'une importance vitale pour obtenir un produit de qualité. La technologie Switch, un IRC élevé ou de nouvelles finitions font partie des nouvelles références.

L'evoluzione è fondamentale per ottenere un prodotto di qualità. La tecnologia Switch, il CRI elevato o le nuove finiture caratterizzano i nuovi prodotti incorporati.

La evolución es de vital importancia para conseguir un producto de calidad. La tecnología Switch, CRI altos o nuevos acabados forman parte de las referencias incorporadas.

Three phase recessed track accessories

Technical Data

Three phase recessed track.

Finishes

Matt Black. Aluminium.

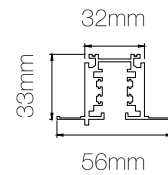
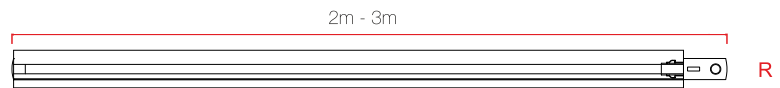

	Code	Color	Meters
Three phase	4753	● Black	2m
recessed track	4754	● Black	3m



Konic Switch

technical lighting

Technical Data

Cylindrical spotlight for three phase track.

Light

LED with SWITCH technology in 2.700K/3.200K/4.000K with CRI>94.

Finishes

White and Matt Black. Aluminium.

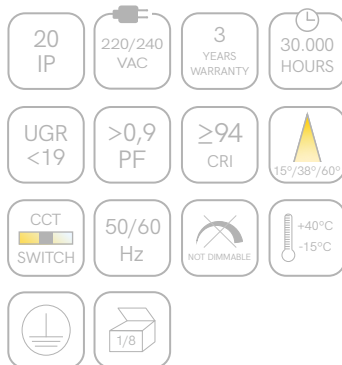
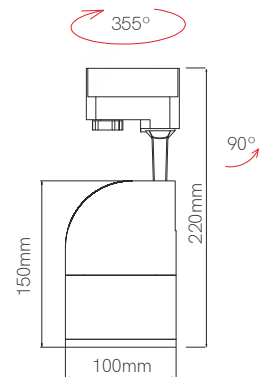

	Code	Color	Power	CCT	Lumens
Konic	4441-N	○ White	30 W	2.700K-3.200K-4.000K	2440 Lm
	4442-N	● Black	30 W	2.700K-3.200K-4.000K	2440 Lm



Kom Switch

technical lighting

Technical Data

Cubic spotlight for three phase track.

Light

LED with SWITCH technology in
2.700K/3.200K/4.000K with CRI>94.

Finishes

White and Matt Black. Aluminium.

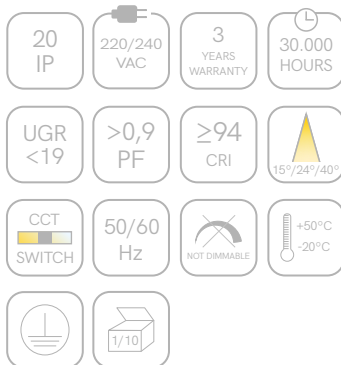
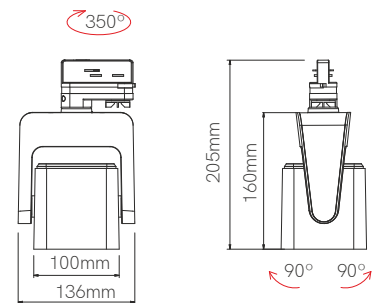

	Code	Color	Power	CCT	Lumens
Kom	4336-N	○ White	30 W	2.700K-3.200K-4.000K	2470 Lm
	4338-N	● Black	30 W	2.700K-3.200K-4.000K	2470 Lm





Aliexpress Plaza Barcelona, Esplugues de Llobregat (Spain).

Nox Switch

technical lighting

Technical Data
Cylindrical ceiling spotlight.

Light
LED with SWITCH technology in
2.700K/3.200K/4.000K with CRI>94.

Finishes
White and Matt Black. Aluminium.

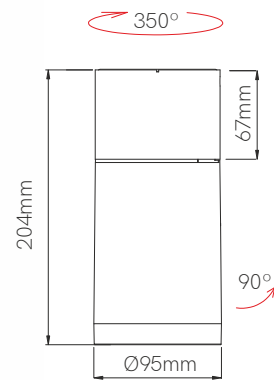

20 IP	220/240 VAC	3 YEARS WARRANTY	30.000 HOURS
UGR <19	>0,9 PF	≥94 CRI	15°/24°/40°
CCT SWITCH	50/60 Hz	NOT DIMMABLE	+50°C -20°C
□	1/8		

	Code	Color	Power	CCT	Lumens
Nox	4241-N	○ White	30 W	2.700K-3.200K-4.000K	2460 Lm
	4242-N	● Black	30 W	2.700K-3.200K-4.000K	2460 Lm



Pure

decorative lighting

Technical Data
Bedside decorative fixture.

Light
LED in 2.700K with three intensities.

Finishes
White and Matt Black. Aluminium.

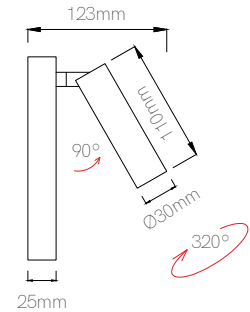
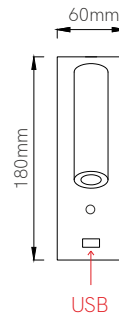

20 IP	220/240 VAC	2 YEARS WARRANTY	30.000 HOURS
>0,9 PF	≥80 CRI	15°/24°/40°	50/60 Hz
3 POSITIONS	+40°C -20°C		1/20

	Code	Color	Power	CCT	Lumens
Pure	4142-V2	○ White	4 W	2.700 K	200/100/50 Lm
	4143-V2	● Black	4 W	2.700 K	200/100/50 Lm



Atmos

decorative lighting

Technical Data

Suspended decorative fixture.

Light

LED with SWITCH technology in 2.700K/3.200K/4.000K with CRI>80.

Finishes

Chrome. Aluminium.

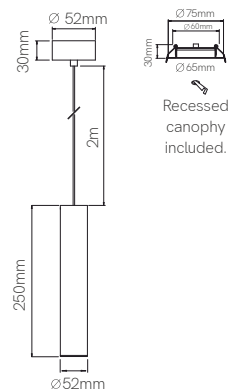

	Code	Color	Power	CCT	Lumens
Atmos 25	4952	● Chrome	7 W	2.700K-3.200K-4.000K	770 Lm

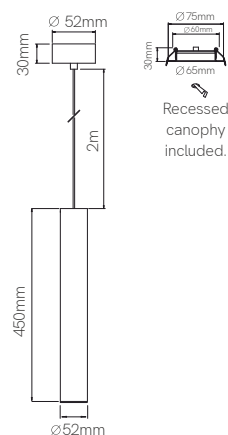

	Code	Color	Power	CCT	Lumens
Atmos 45	4953	● Chrome	10 W	2.700K-3.200K-4.000K	1100 Lm

20 IP	220/240 VAC	3 YEARS WARRANTY	30.000 HOURS
UGR <19	>0,9 PF	≥80 CRI	15°/38°/60°
CCT SWITCH	50/60 Hz	NOT DIMMABLE	+50°C -20°C





Showroom Beneito Faure, La Roca del Vallés (Spain).

Atmos GU10

decorative lighting

Technical Data

Suspended decorative fixture for dichroic GU10 bulb.

Light

Bulbholder GU10 included.

Finishes

Chrome. Aluminium.

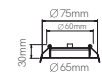
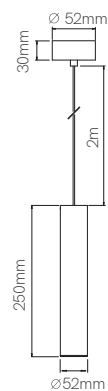

Recessed canopy included.

Recommended Dichroic: Catalogue C30

	Code	Color
Atmos 25	4954	● Chrome

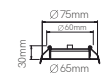
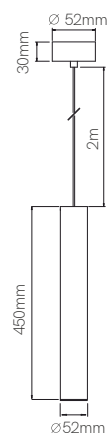

Recessed canopy included.

Recommended Dichroic: Catalogue C30

	Code	Color
Atmos 45	4955	● Chrome





Concord Switch

decorative lighting

Technical Data

Decorative cylindrical ceiling or wall lamp.

Light

LED with SWITCH technology in 2.700K/3.200K/4.000K with CRI>97.

Finishes

White and Matt Black. Aluminium.

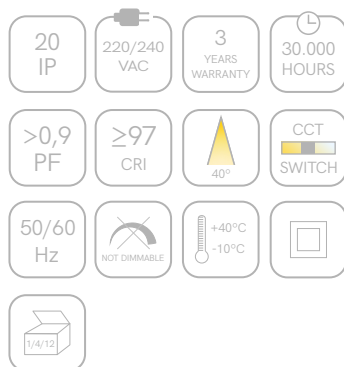
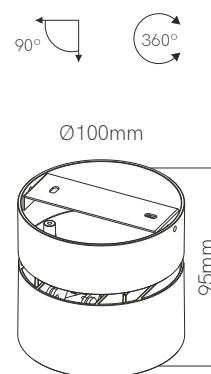

	Code	Color	Power	CCT	Lumens
Concord	4232-N	○ White	14 W	2.700K-3.200K-4.000K	1205 Lm
	4233-N	● Black	14 W	2.700K-3.200K-4.000K	1205 Lm



Rubyc Switch

decorative lighting

Technical Data

Decorative cubic ceiling or wall lamp.

Light

LED with SWITCH technology in
2.700K/3.200K/4.000K with CRI>97.

Finishes

White and Matt Black. Aluminium.

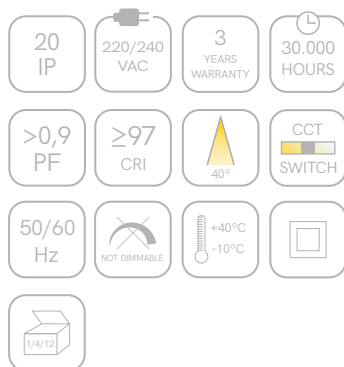
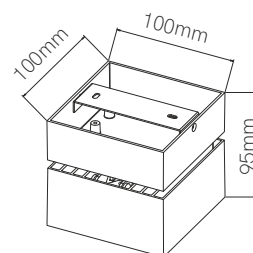
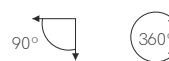

	Code	Color	Power	CCT	Lumens
Rubyc	4230-N	○ White	14 W	2.700K-3.200K-4.000K	1205 Lm
	4231-N	● Black	14 W	2.700K-3.200K-4.000K	1205 Lm



Thesis Dimmable downlights

Technical Data

Dimmable recessed downlight.

Light

LED with SWITCH technology in
2.700K/3.200K/4.000K.

Finishes

White. Polybutylene and
Polycarbonate.

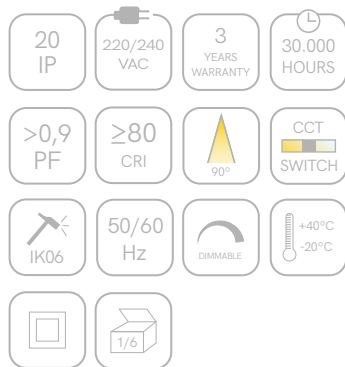
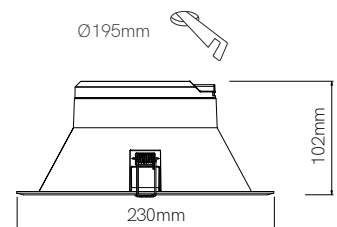

	Code	Color	Power	CCT	Lumens
Thesis Dimmable	4691	○ White	25 W	3.000K-4.000K-5.000K	2.625 Lm





Cam 60cm

outdoor lighting

Technical Data

Outdoor fixture 60cm high with Ik08.

Light

LED in 3.000K with IP54.

Finishes

White and Matt Black. Aluminum.

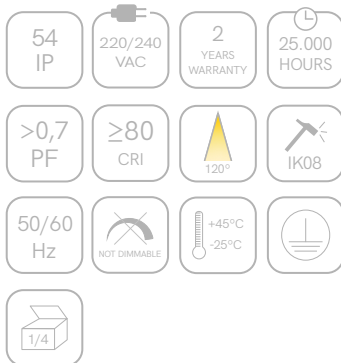
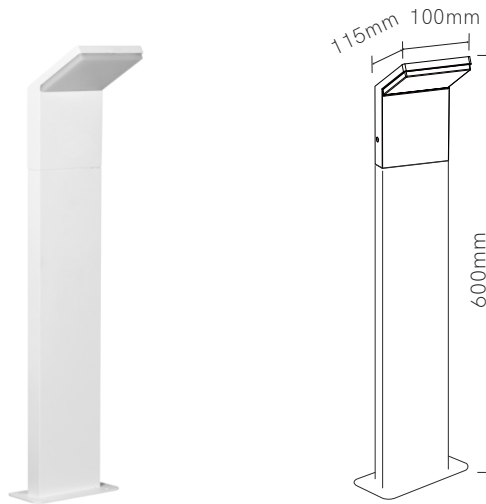

	Code	Color	Power	CCT	Lumens
Cam 60cm	4709	○ White	9 W	3.000 K	690 Lm
	4710	● Black	9 W	3.000 K	690Lm





Selen

outdoor lighting

Technical Data
Outdoor cylindrical fixture.

Light
LED in 3.000K or 4.000K with IP65.

Finishes
White. Polycarbonate.

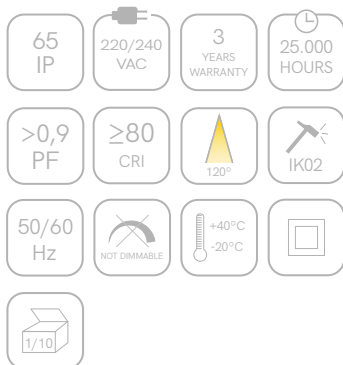
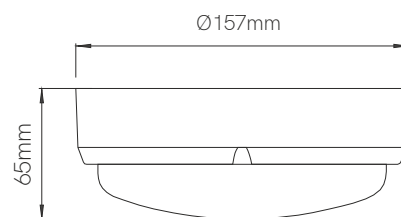

	Code	Color	Power	CCT	Lumens
Selen	4668	○ White	12 W	3.000 K	1.200 Lm
	4667	○ White	12 W	4.000 K	1.250 Lm



Zibor

outdoor lighting

Technical Data
Outdoor rectangular fixture.

Light
LED in 3.000K or 4.000K with IP65.

Finishes
White. Polycarbonate.

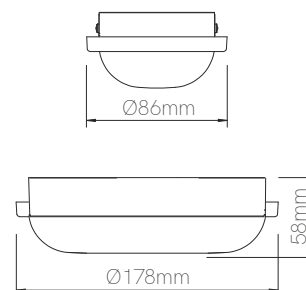
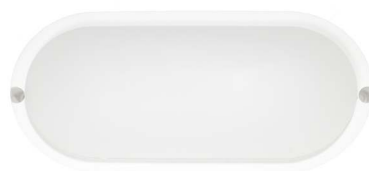

65 IP	220/240 VAC	3 YEARS WARRANTY	25.000 HOURS
>0,9 PF	≥80 CRI	120°	IK02
50/60 Hz	NOT DIMMABLE	+40°C -20°C	
1/10			

	Code	Color	Power	CCT	Lumens
Zibor	4670	○ White	12 W	3.000 K	1.200 Lm
	4669	○ White	12 W	4.000 K	1.250 Lm



Sky 10W Switch

outdoor lighting

Technical Data
Outdoor spotlight with IK08.

Light
LED with SWITCH technology in
3.000K/4.000K/5.000K with IP65.

Finishes
White, Black and Grey. Aluminium.

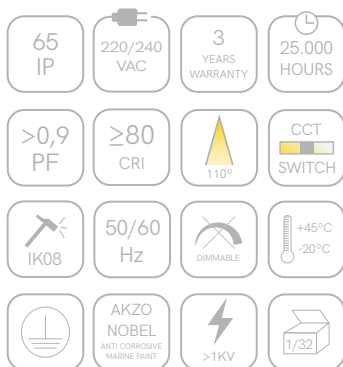
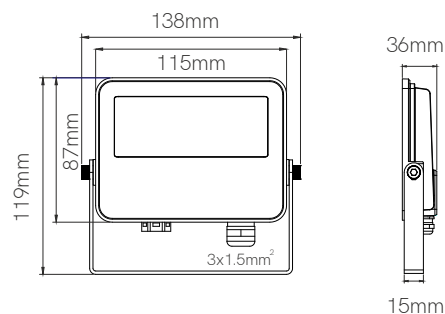

	Code	Color	Power	CCT	Lumens
Sky 10W	4679	○ White	10 W	3.000K-4.000K-5.000K	1.200 Lm
	4680	● Black	10 W	3.000K-4.000K-5.000K	1.200 Lm
	4681	● Gray	10 W	3.000K-4.000K-5.000K	1.200 Lm



Sky 20W Switch

outdoor lighting

Technical Data

Outdoor spotlight with IK08.

Light

LED with SWITCH technology in 3.000K/4.000K/5.000K with IP65.

Finishes

White, Black and Grey. Aluminium.

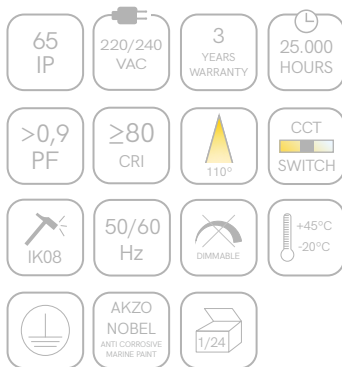
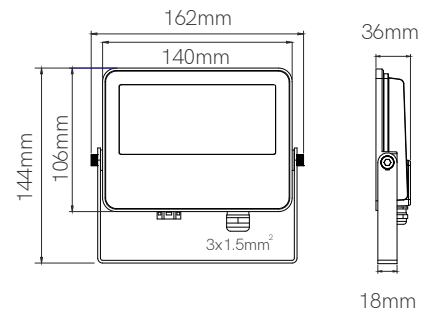

	Code	Color	Power	CCT	Lumens
Sky 20W	4682	○ White	20 W	3.000K-4.000K-5.000K	2.400 Lm
	4683	● Black	20 W	3.000K-4.000K-5.000K	2.400 Lm
	4684	● Gray	20 W	3.000K-4.000K-5.000K	2.400 Lm



Sky 30W Switch

outdoor lighting

Technical Data

Outdoor spotlight with IK08.

Light

LED with SWITCH technology in 3.000K/4.000K/5.000K with IP65.

Finishes

White, Black and Grey. Aluminium.

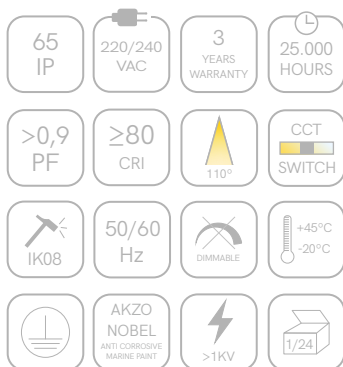
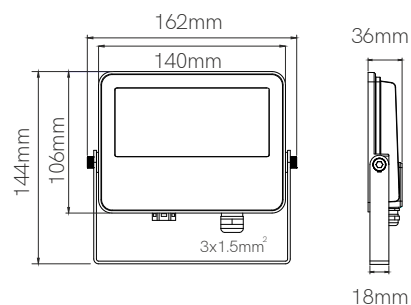

	Code	Color	Power	CCT	Lumens
Sky 30W	4685	○ White	30 W	3.000K-4.000K-5.000K	3.600 Lm
	4686	● Black	30 W	3.000K-4.000K-5.000K	3.600 Lm
	4687	● Gray	30 W	3.000K-4.000K-5.000K	3.600 Lm



Sky 40W Switch

outdoor lighting

Technical Data

Outdoor spotlight with IK08.

Light

LED with SWITCH technology in 3.000K/4.000K/5.000K with IP65.

Finishes

White, Black and Grey. Aluminium.

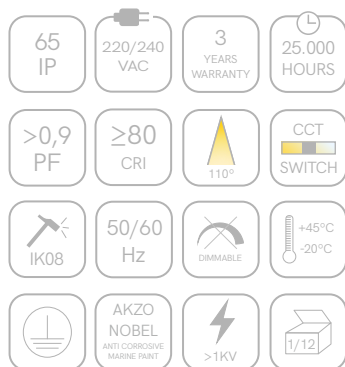
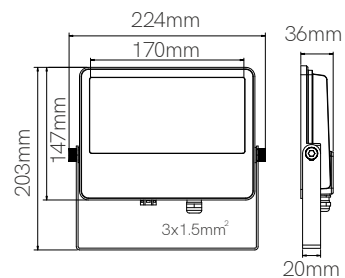

	Code	Color	Power	CCT	Lumens
Sky 40W	4688	○ White	40 W	3.000K-4.000K-5.000K	4.800 Lm
	4689	● Black	40 W	3.000K-4.000K-5.000K	4.800 Lm
	4694	● Gray	40 W	3.000K-4.000K-5.000K	4.800 Lm



Globo 15W

retrofit

Technical Data

Bulb E27 with 120mm diameter.

Light

LED in 2.700K or 4.000K.

Finishes

White.



	Code	Color	Power	CCT	Type	Lumens
Globo	4677	○ White	15 W	2.700 K	E27	1400 Lm
	4678	○ White	15 W	4.000 K	E27	1500 Lm



Narrow Dimmable retrofit

Technical Data

Dimmable dichroic GU10 bulb.

Light

LED in 2.700K or 3.000K.

Finishes

White.



40 IP	220/240 VAC	3 YEARS WARRANTY	25.000 HOURS
>0,8 PF	≥80 CRI	15°	50/60 Hz
DIMMABLE	+40°C -20°C	10/50	

	Code	Color	Power	CCT	Type	Lumens
Narrow	4672	○ White	7 W	2.700 K	GU10	400 Lm
Dimmable	4671	○ White	7 W	3.000 K	GU10	420 Lm



CONDITIONS



PRICES UPDATE - INTERNET UPDATE - PDF

Our interest in new solutions and for the development of lighting technology and lighting industry, makes us constantly innovating.

This is why BENEITO FAURE offers to its customers a frequently online updated (PDF) to inform about all our news.

You can find all the information on our website:

www.beneito-faure.com

IMPORTANT:

All information on the website can be cancelled and replaced by another one, and will be the last update the only right one.



TARIFA BENEITO FAURE - ACTUALIZACION DIGITAL - PDF

Nuestra implicación desde BENEITO FAURE por una continua elaboración de soluciones avanzadas, junto al progresivo cambio tecnológico de la industria de la iluminación en los últimos años, nos hace estar en constante innovación.

Por ello, ponemos al servicio de todos nuestros clientes una actualización frecuente on-line (formato PDF) con la intención de tenerlos informados en todo momento de las últimas novedades de BENEITO FAURE.

La mencionada actualización se encuentra disponible en nuestra página WEB:

www.beneito-faure.com

IMPORTANTE:

Cualquier información publicada quedará anulada y sustituida por la que aparece en cada momento en nuestra WEB, siendo esta la única con validez y vigencia de gama y precios de venta recomendados.



GENERAL CONDITIONS OF SALE

BENEITO FAURE S.L reserves the right to make the variations it deems appropriate to its products, not being responsible for the possible erroneous information that appears in the catalog.

RATE

For any type of order the rate and conditions in force at the time of receipt of the order will apply. The rate will be sent via email to all customers in the BENEITO FAURE database and will be updated whenever necessary. Prices do not include VAT if recycling rate.

ORDERS

Orders must be sent via email. No order will be placed by phone or any other means. The quote of the material to be made to measure will be sent to the customer for acceptance and will not be processed prior receiving the copy signed for acceptance.

RETURNS

To make any return, the authorization must be requested from BENEITO FAURE. The return of the material must be communicated by e-mail indicating the customer's name, the reason of the return, the date of purchase, the number of units and the reference of the product to be returned. It is mandatory to attach a copy of the purchase invoice. The acceptance of the return does not imply the definitive acceptance of it. The return will be definitive only after the subsequent verification and analysis of the product by our technical department. Returns of merchandise will only be accepted if in perfect condition for sale and in the original packaging in good condition. The packaging label must also be intact. Returns will not be compensated by an economic amount and must be sent by means of the client's transport. The return of material may be compensated by prior order and with the authorization of BENEITO FAURE. The return of the products made to measure or previously processed by the technical department due to the customer's request, will not be accepted.

TRANSPORT

Unless other transport terms are agreed, the merchandise will travel on behalf of those purchased with the EXWORKS conditions. Likewise, BENEITO FAURE will offer a delivery time for each territory, this being always approximate. The company will not be responsible for possible alterations or delays on this time caused by causes outside the company.

PROPERTY RESERVATION

BENEITO FAURE reserves the right to own all the materials that it supplies until the buyer has paid the total amount thereof.

The requested goods are supplied under reservation of ownership in favor of BENEITO FAURE

The client is obliged to cooperate and take all steps necessary or desirable, and to propose or need to BENEITO safeguard their ownership of the goods. The serve of domain remains even in the event that the client had accepted and recognized credits against BENEITO or had established a system of accounts between them. The transformation or improvement of goods on which BENEITO has reserve domain, does not give property to client or manipulative. In case of union, transformation and/or accession of goods under domain's reserve to thirds, subsist the domain's reserve in proportion to the value that the goods subject had to domain's reserve before to accession. The client may sell the goods subject to domain's reserve in the ordinary course of business, provided those no breach his payment obligations to BENEITO. Upon a resale of goods subject to domain's reserve, occurs automatically the transfer to BENEITO of credits arising of that sale to the seller, and any other credit arising in the case of compensation for loss of thing, tort-contract, etc. in such cases, the client is obliged to BENEITO to provide all information and documentation necessary for the claim of the subrogated credits. In case of default by the client, in particular, in the case of late payment, or if a declaration of bankruptcy of the client, BENEITO claim by notifying the client, in possession of the goods, being obligated to BENEITO to provide all information and documentation necessary for the claim of the subrogated credits. In case of default by the client, in particular, in the case of late payment, or if a declaration of bankruptcy of the client, BENEITO claim by notifying the client, in possession of the goods, being obliged it to give them. If before performed the pay of total price, the goods sold were affected by some lien or lock, the client shall be obliged to sate explicitly in the diligence of the embargo, that the goods are owned by BENEITO and if, despite this, were seized, must facilitate to BENEITO the exercise by the relevant third domain action, whose expenses will be paid by the client.

DELIVERY TERM

The availability terms offered by BENEITO FAURE are always approximate and may be subject to variations. These possible variations in the terms will not imply the acceptance of the responsibility or penalties for the delay by BENEITO FAURE.

CLAIMS

On the delivery note of the carrier, any visible anomaly must be recorded and, after having reviewed the material, communicate in writing to our offices the incident within 24 hours of receiving the merchandise. Once this time has elapsed, the company will not be able to take charge of the claim because it is not in time for the transport agency. For other types of claims, you must contact our offices by written email. The product that does not work correctly will be replaced by the same article or another with the same characteristics. In no case will we be responsible for the costs of labor that may be caused by the malfunction of a product in our catalog.

WARRANTY

BENEITO FAURE guarantees that the products sold are in perfect condition. The warranty will cover the repair or replacement of the product (under the decision of BENEITO FAURE) and it will be necessary to send the incident by email. The product warranty is in its packaging. The technical department of BENEITO FAURE will be the only one authorized to determine if it is a manufacturing defect, after receiving the incident and the sales invoice in writing for prior verification. BENEITO FAURE quantifies the warranty time considering the date of the customer's purchase invoice and not on the hours of operation of the product.

The WARRANTY will not be covered:

1. If the product has been previously handled.
2. It is not installed according to the instructions.
3. If the ventilation of which is not adequate.
4. Problems with partial or total payment by the client.

JURISDICTION

In any discrepancy or dispute, both parties will submit to the jurisdiction of the Judges and courts of Barcelona.



ALLGEMEINE GESCHÄFTSBEDINGUNGEN

BENEITO FAURE S.L behält sich das Recht, etwaige, für erforderlich gehaltene Änderungen an den Produkten vorzunehmen, und ist nicht für mögliche Fehlinformationen im entsprechenden Katalog haftbar.

PREISLISTE

Alle Bestellungen unterliegen der zum Zeitpunkt der Bestellung geltenden Preisliste und den entsprechenden Geschäftsbedingungen. Die Preisliste wird per E-Mail an alle Kunden, die sich in der Datenbank von BENEITO FAURE befinden, geschickt und wird, wenn erforderlich, entsprechend aktualisiert werden. Die Preise enthalten weder die Mehrwertsteuer noch die Recyclinggebühr.

BESTELLUNGEN

Bestellungen müssen per E-Mail geschickt werden. Es werden keine Bestellungen telefonisch oder auf sonstigem Wege entgegengenommen. Der Kostenvoranschlag bzw. das Angebot für das nach Kundenvorgaben anzufertigende Produkt, wird dem Kunden zur Prüfung und zur Freigabe zugesandt und wird erst nach Erhalt der geprüften Auftragsfreigabe bearbeitet.

RÜCKGABEN

Alle Rückgaben müssen vorab bei BENEITO FAURE beantragt und von der Firma genehmigt werden. Die Rücksendung-Anfrage des Materials muss per E-Mail unter Angabe des Kundennamens, des Grundes der Rücksendung, des Kaufdatums, der Anzahl der Einheiten und der Referenz des zurückzusendenden Produkts erfolgen. Es ist zwingend erforderlich, eine Kopie der Kaufrechnung beizufügen. Die Annahme der Rücksendung bedeutet nicht die endgültige Annahme. Die Rücksendung ist erst nach der anschließenden Überprüfung und Analyse des Produkts durch unsere technische Abteilung endgültig. Warenrücksendungen werden nur akzeptiert, wenn sie sich in einwandfreiem Zustand zum Verkauf und in der Originalverpackung in gutem Zustand befinden. Das Verpackungsetikett muss ebenfalls intakt sein. Rückgaben werden nicht durch einen Geldbetrag ausgeglichen und müssen vom Kunden mit eigenen Transportmitteln geschickt werden. Die Materialrückgabe kann, nach Genehmigung von BENEITO FAURE, durch eine Vorbestellung ausgeglichen werden. Die Rücksendung der nach Maß gefertigten oder zuvor von der technischen Abteilung auf Kundenwunsch gefertigten Produkte wird nicht akzeptiert.

TRANSPORT

Außer im Falle von gesondert vereinbarten Transportbedingungen, wird die Ware unter ex-works Bedingungen zu Lasten des Käufers versendet werden. BENEITO FAURE wird die Lieferzeiten stets dem Empfangsort entsprechend angeben, wobei es sich immer um annähernde Zeiten handeln wird. Das Unternehmen ist nicht für etwaige Änderungen oder Verspätungen haftbar, die sich aus Gründen, die nicht vom Unternehmen zu verantworten sind, ergeben.

EIGENTUMSVORBEHALT

BENEITO FAURE behält sich das Eigentumsrecht auf alle gelieferten Materialien, bis der Käufer den gesamten Kaufbetrag beglichen hat.

Die bestellten Waren werden unter Eigentumsvorbehalt zu Gunsten von BENEITO geliefert, bis der Kunde allen Zahlungsverpflichtungen nachgekommen ist. Der Kunde verpflichtet sich, zu kooperieren und alle notwendigen oder angemessenen Maßnahmen und solche Maßnahmen, die BENEITO vorschlägt oder benötigt, zu ergreifen, um sein Eigentum über die Ware zu schützen. Der Eigentumsvorbehalt besteht selbst dann weiter, wenn der Kunde akzeptierte und anerkannte Forderungen gegenüber BENEITO hätte, oder wenn ein System laufender Konten zwischen beiden Parteien bestünde. Die Transformation oder Verbesserung der Ware für die BENEITO einen Eigentumsvorbehalt hat, überträgt sein Eigentum nicht an den Kunden oder den Anwender. Im Falle von Zusammenführung, Transformation und/oder Beistellung von Produkten unter Eigentumsvorbehalt mit Produkten von Dritten besteht der Eigentumsvorbehalt in Proportion entsprechend dem Wert, den die Produkte mit Eigentumsvorbehalt vor der Beistellung hatten, fort. Der Kunde kann die Waren unter Eigentumsvorbehalt im Rahmen seiner gewöhnlichen Geschäfte verkaufen, solange er seinen Zahlungsverpflichtungen gegenüber BENEITO nachkommt. In jedem Fall erfolgt bei einem Wiederverkauf der Waren unter Eigentumsvorbehalt automatisch eine Abtretung der aus diesem Wiederverkauf entstehenden Forderungen zugunsten des Verkäufers an BENEITO, sowie eine Abtretung aller anderen Forderungen, die ggf. als Entschädigungen durch Warenverlust, außervertragliche Haftung usw. entstehen. Der Kunde ist in diesen Fällen dazu verpflichtet, BENEITO alle für die Reklamation der übertragenen Forderungen notwendigen Informationen und Unterlagen zur Verfügung zu stellen. Im Falle einer Nichteinhaltung seitens des Kunden, und insbesondere im Fall von verspäteten Zahlungen oder Konkurserklärung seitens des Kunden, reklamiert BENEITO als Eigentümer der Ware, nach vorheriger Mitteilung an den Kunden, die Zurückgabe der Ware seitens des Kunden. Sollte die verkaufte Ware vor der vollständigen Bezahlung des Preises Gegenstand von Pfändung oder Handelshemmnis werden, ist der Kunde verpflichtet, bei der Pfändungsmaßnahme ausdrücklich darauf hinzuweisen, dass die Waren Eigentum von BENEITO sind und, sollten sie trotz dieser Erklärung gepfändet werden, die Durchführung des entsprechenden Drittwiderspruchs, dessen Kosten zu Lasten des Kunden gehen, seitens BENEITO zu ermöglichen.

LIEFERZEIT

Die von BENEITO FAURE genannten Lieferzeiten und Verfügbarkeiten verstehen sich immer als ca. Angaben und können Änderungen unterliegen. Diese möglichen Änderungen der Lieferzeiten bedeuten nicht die Anerkennung der Verantwortung oder die Auferlegung einer Strafe als Folge des Verzugs durch BENEITO FAURE.

REKLAMATIONEN

Jegliche sichtbaren Mängel müssen auf dem Lieferschein des Transportunternehmens eingetragen werden. Nach Prüfung der Ware, müssen etwaige Vorfälle unserer Firma innerhalb der nächsten 24 Stunden schriftlich mitgeteilt werden. Nach dieser Frist übernimmt die Firma keine Haftung für Reklamationen, da die vom Transportunternehmen vorgeschriebene Frist abgelaufen ist. Im Falle sonstiger Reklamationen müssen diese unserer Verwaltung schriftlich mitgeteilt werden. Produkte, die nicht korrekt funktionieren, werden durch gleiche Produkte, oder Produkte mit den gleichen Eigenschaften, ersetzt. In keinem Fall werden wir die Arbeitskosten übernehmen, die sich aus der Fehlfunktion eines Produkts aus unserem Katalog ergeben könnten.

GARANTIE

BENEITO FAURE garantiert, dass die verkauften Produkte sich in perfektem Zustand befinden. Die Garantie deckt die Reparatur oder den Ersatz des Produkts (nach Entscheidung von BENEITO FAURE). Der Fall muss jedoch vorab per E-Mail angezeigt werden. Die Produktgarantie befindet sich in der Produktverpackung. Die technische Abteilung von BENEITO FAURE ist die einzige autorisierte Stelle, um die Entscheidung zu treffen, ob es sich um einen Herstellungsfehler handelt, nachdem der Fall schriftlich gemeldet wurde, samt Rechnung, zur entsprechenden Prüfung. BENEITO FAURE bewertet die Garantiezeit unter Berücksichtigung des Datums der Kaufrechnung des Kunden und nicht anhand der Betriebsstunden des Produktes.

Die GARANTIE gilt nicht:

1. Wenn das Produkt manipuliert wurde.
2. Wenn das Produkt nicht gemäß Anleitungen installiert wurde.
3. Wenn die Produktbelüftung nicht geeignet ist.
4. Wenn Probleme für die teilweise oder vollständige Zahlung durch den Kunden vorliegen.

GERICHTSBARKEIT

Im Falle etwaiger Uneinigkeiten oder Streitfälle, werden sich beide Parteien der Gerichtsbarkeit der Richter und Gerichte von Barcelona unterwerfen.



CONDITIONS GÉNÉRALES DE VENTE

BENEITO FAURE S.L. se réserve le droit de faire les variations qu'elle juge appropriées à ses produits n'étant pas responsable de toute information erronée qui apparaît dans le catalogue.

TARIF

Pour tout type de commande, nous appliquerons les tarifs et conditions en vigueur au moment de la réception de la commande. Le tarif sera envoyé par e-mail à tous les clients qui sont dans la base de données de BENEITO FAURE et sera mis à jour si nécessaire. Les prix n'incluent pas la TVA.

COMMANDES

Les commandes doivent être envoyées par EMAIL. Aucune commande ne sera passée par téléphone ou par tout autre moyen. Les devis de matériel qui doit être manipulé sur mesure seront soumis au client pour validation et ne seront pas traités avant de recevoir la copie signée du bon pour accord.

RETOURS

Pour tout retour, une autorisation préalable doit être demandée à BENEITO FAURE. Il faudra communiquer le motif du retour par courrier électronique en indiquant le nom du client, la date d'achat, les unités et la référence du produit retourné, le motif du retour et le bon de livraison concerné. L'acceptation du retour n'implique pas l'acceptation définitive de celui-ci. Le retour ne sera définitif qu'après vérification et analyse du produit par notre service technique. Les retours de marchandises ne seront acceptés que si le matériel est en parfait état pour la vente et dans son emballage d'origine en bon état, ainsi que l'étiquette de l'emballage. Les retours ne seront pas compensés par un montant économique et ils devront être envoyés par le biais du transport du client. Le retour du matériel peut être compensé au moyen d'une commande préalable et avec l'autorisation de BENEITO FAURE. Nous n'accepterons pas les retours de produits de fabrication spéciale ou préalablement manipulés par le service technique à la demande du client.

TRANSPORT

Sauf convention contraire, les marchandises voyagent pour le compte de ceux qui achètent aux conditions EXWORKS. De même, BENEITO FAURE proposera un délai de livraison pour chaque territoire, toujours approximatif. La société ne sera pas responsable d'éventuelles modifications ou retards sur ce délai produits par des causes externes à la société.

RÉSERVE DE PROPRIÉTÉ

BENEITO FAURE se réserve la propriété de tous les matériaux qu'elle fournit jusqu'au paiement intégral par l'acheteur.

La marchandise commandée est livrée sous réserve de propriété en faveur de BENEITO FAURE jusqu'à l'exécution complète des obligations de paiement du client.

Le client est tenu de coopérer et de prendre les mesures nécessaires et celles que BENEITO FAURE propose pour préserver sa propriété des marchandises. La réservation du domaine persiste même si le client a accepté et reconnu des crédits sur BENEITO FAURE ou si un système de comptes courants a été établi entre eux. La transformation ou l'amélioration de la marchandise sur laquelle BENEITO FAURE a une réserve de propriété ne confère pas sa propriété au client ou au manipulateur. Toute supposition d'union, de transformation et/ou d'adhésion des produits sous la réserve de dominion aux produits de tiers subsistera la réserve de dominion dans la proportion correspondant à la valeur qui avait les produits objet de la réserve de dominion avant l'adhésion. Le client peut vendre la marchandise sous réserve de propriété dans le cours normal de ses affaires, à condition qu'il n'ait pas manqué à ses obligations de paiement envers BENEITO FAURE. En tout état de cause, en cas de revente de marchandises sous réserve de propriété, il y a cession de plein droit à BENEITO FAURE des crédits nés de cette revente en faveur du vendeur, ainsi que de tous autres crédits antérieurs, en cas d'indemnisation pour perte de la chose, responsabilité civile, etc. Dans ces cas, le client sera tenu de fournir à BENEITO FAURE toutes les informations et documents nécessaires à la réclamation des crédits subrogés. En cas de non-respect de la part du client, et notamment en cas de retard de paiement ou de déclaration de faillite du client, BENEITO FAURE se réserve le droit de réclamer, moyennant notification préalable au client, la possession des marchandises, le client étant tenu de les lui livrer. Si, avant le paiement intégral du prix, les marchandises vendues font l'objet d'une saisie ou d'un empêchement, le client est tenu de déclarer expressément, dans le cadre de la saisie, que les marchandises sont prioritaires pour BENEITO FAURE et si, malgré cette déclaration, elles sont saisies, BENEITO FAURE pourra exercer l'action correspondante du tiers, dont les frais seront à charge du client.

TEMPS DE LIVRAISON

Les périodes de disponibilité offertes par BENEITO FAURE sont toujours approximatives et peuvent faire l'objet de variations. Ces éventuelles variations de conditions n'impliquent pas l'acceptation de responsabilité ou de pénalités de retard de la part de BENEITO FAURE.

RÉCLAMATIONS

Le bon de livraison du transporteur doit mentionner toute anomalie visible et, après examen du matériel, communiquer par écrit à nos bureaux l'incident dans les 24 heures suivant la réception des marchandises. Passé ce délai, l'entreprise ne pourra pas prendre en charge la réclamation pour ne pas être dans le délai par l'agence de transport. Pour les autres types de réclamations, vous devez communiquer par écrit à nos bureaux. Le produit qui ne fonctionne pas correctement sera remplacé par un autre égal ou qui remplit les mêmes caractéristiques. En aucun cas nous ne prendrons en charge les coûts de main d'œuvre qui peuvent être occasionnés par le dysfonctionnement d'un produit de notre catalogue.

GARANTIE

BENEITO FAURE garantit que les produits vendus sont en parfait état. La garantie couvrira la réparation ou le remplacement du produit (à la discrétion de BENEITO FAURE) et il sera nécessaire d'envoyer l'incident par email. La garantie du produit se trouve sur l'emballage du produit. Le service technique de BENEITO FAURE sera le seul autorisé à déterminer s'il s'agit d'un défaut de fabrication, après avoir reçu par écrit l'incidence et la facture de vente pour vérification préalable. BENEITO FAURE base la période de garantie sur les années écoulées depuis l'achat du produit par le client, et non sur les heures d'utilisation du produit.

La GARANTIE ne sera pas couverte :

1. Si le produit a déjà été manipulé.
2. N'a pas été installé conformément aux instructions.
3. Si la ventilation n'est pas suffisante.
4. Problèmes de paiement partiel ou total par le client.

JURIDICTION

En cas de désaccord ou de litige, les deux parties se soumettront à la juridiction des juges et tribunaux de Barcelone.



CONDIZIONI GENERALI DI VENDITA

BENEITO FAURE S.L. si riserva il diritto di realizzare le variazioni che considera opportune sui propri prodotti non essendo responsabile di possibili informazioni errate che possono apparire nel catalogo.

LISTINO PREZZI

Per qualsiasi ordine si applicano le condizioni di vendita in vigore al momento della ricezione dello stesso. Il listino prezzi è inviato tramite mail a tutti i clienti inseriti nel data base di BENEITO FAURE e può essere aggiornato in qualsiasi momento se necessario. I prezzi sono da intendersi IVA esclusa. Tassa di riciclaggio inclusa.

ORDINI

Gli ordini devono essere inviati esclusivamente tramite mail. Non sarà processato nessun ordine via telefono o tramite altri mezzi. I preventivi del materiale che deve essere fatto su misura saranno inviati al cliente per accettazione e non saranno elaborati fino al ricevimento della copia firmata per accettazione.

RESI

Per procedere con qualsiasi reso è necessario ricevere l'autorizzazione di BENEITO FAURE. Il motivo del reso deve essere comunicato tramite e-mail indicando il nome del cliente, la data di acquisto, le unità ed il riferimento del prodotto da rendere. È obbligatorio allegare sempre la copia della fattura d'acquisto. L'accettazione del reso non implica l'accettazione definitiva dello stesso. Il reso sarà definitivo solo dopo la successiva verifica ed analisi del prodotto da parte del nostro ufficio tecnico. I resi di merce saranno accettati solo se in perfette condizioni per la vendita e nella confezione originale in buone condizioni. Anche l'etichetta dell'imballo deve essere integra. I resi non vengono rimborsati e devono essere spediti unicamente dal cliente all'azienda. I resi vengono compensati con articoli sostitutivi tramite autorizzazione di BENEITO FAURE. Non saranno accettati resi di prodotti fatti su misura o precedentemente trattati dall'ufficio tecnico su richiesta del cliente.

CONSEGNA

A meno che non si accordino speciali condizioni e termini, il trasporto è a carico del destinatario: EX-WORKS. Alternativamente BENEITO FAURE dispone di un servizio di consegna per ogni territorio e la resa ed il presso variano a seconda della destinazione. L'azienda non si fa carico di eventuali danni o alterazioni subiti dalla merce durante il trasporto non imputabili dall'azienda stessa.

DIRITTO DI PROPRIETÀ

BENEITO FAURE si riserva il diritto e la proprietà di tutto il materiale che somministra fino al momento in cui il cliente finale abbia totalmente pagato il materiale stesso.

La merce si somministra sotto la riserva di proprietà di BENEITO FAURE fino al totale adempimento delle obbligazioni da parte del cliente.

Il cliente è obbligato a cooperare e adottare tutte le misure necessarie o convenienti e quelle proposte da BENEITO FAURE per salvaguardare la sua proprietà del prodotto. La riserva di proprietà persiste anche quando viene accettato e riconosciuto il credito del cliente da BENEITO FAURE o se si fosse stabilito un sistema di pagamento tra le parti. Le trasformazioni o i miglioramenti della merce sulla quale BENEITO FAURE ha la riserva di proprietà, non assegnano la proprietà al cliente o al manipolatore. In caso di unione, trasformazione e/o adesione dei prodotti sotto la di proprietà di terzi sussisterà la riserva di proprietà in proporzione al valore che avevano i prodotti oggetto di riserva di proprietà prima dell'adesione. Il cliente potrà vendere i beni soggetti a riserva di proprietà nell'ambito dei suoi affari, sempre e quando non ci siano violazioni delle obbligazioni nei confronti di BENEITO FAURE. In tutti i casi quando si genera una rivendita di merce soggetta a diritto di proprietà, si genera automaticamente la cessazione a BENEITO FAURE dei crediti conseguenti alla rivendita in favore del venditore, così come si qualsiasi altro credito precedente, nel suo caso di indennizzo per perdita della cosa, responsabilità extracontrattuale, ecc. Il cliente sarà obbligato in questo caso a fornire a BENEITO FAURE tutte le informazioni e i documenti necessari per i reclami. BENEITO FAURE reclamerà, previa notifica del cliente in possesso della merce, essendo quest'ultimo obbligato a fornirla. Se prima di effettuare il pagamento totale, la merce venduta fosse soggetta a qualsiasi tipo di sequestro o blocco, il cliente sarà obbligato a dichiarare nel documento di sequestro che la merce è proprietà di BENEITO FAURE e se, indipendentemente da questo la merce fosse sequestrata, il cliente deve supportare BENEITO FAURE alla rivalsa del diritto di proprietà le cui spese saranno a carico del cliente.

TEMPI DI CONSEGNA

I tempi di consegna offerti da BENEITO FAURE sono sempre approssimati e possono essere soggetti a variazioni. Queste possibili variazioni non implicano l'accettazione di eventuali responsabilità o penalizzazioni subite a cause del ritardo di BENEITO FAURE.

RECLAMI

Nel documento di trasporto dell'autista deve essere segnalata qualsiasi visibile anomalia. Deve essere effettuato il controllo della merce e segnalato all'azienda entro e non oltre le 24 ore dalla ricezione. Superato questo tempo, l'azienda non si farà carico del reclamo per il ritardo dovuto all'agenzia di trasporto. Qualsiasi altro reclamo dovrà essere trasmesso in forma scritta all'azienda. Il prodotto non funzionante sarà sostituito con il corrispettivo uguale o che presenti le medesime caratteristiche. In nessun caso l'impresa si farà carico dei costi sostenuti per il mal funzionamento di un prodotto del nostro catalogo.

GARANZIA

Beneito Faure garantisce che i prodotti vengono venduti in perfetto stato. La garanzia copre la riparazione o la sostituzione del prodotto (sotto conferma di BENEITO FAURE) ed è necessario l'invio della contestazione via mail. La garanzia del prodotto si trova all'interno dell'imballo. Il dipartimento tecnico di BENEITO FAURE sarà l'unico autorizzato a determinare se si tratta di un difetto di fabbricazione, dopo aver ricevuto in forma scritta la contestazione e la fattura di vendita per poter verificare l'effettivo periodo di garanzia. BENEITO FAURE quantifica il tempo di garanzia considerando la data della fattura di acquisto del cliente e non sulle ore di funzionamento del prodotto.

La GARANZIA non sarà valida se:

1. Il prodotto viene manomesso o manipolato
2. Il prodotto non è installato come da istruzioni
3. La ventilazione del prodotto non è adeguata
4. Il cliente ha problemi con i pagamenti, sia in forma parziale che totale.

FORO DI COMPETENZA

In qualunque caso di discrepanza o controversia, ambe le parti si dovranno riferire al foro di competenza dei Giudici e del Tribunale di Barcellona.



CONDICIONES GENERALES DE VENTA

BENEITO FAURE S.L se reserva el derecho a realizar las variaciones que considere oportunas a sus productos no siendo responsables de la posible información errada que aparezca en dicho catálogo.

TARIFA

Para cualquier tipo de pedido se aplicará la tarifa y condiciones vigentes en el momento de la recepción del pedido. La tarifa se enviará vía email a todos los clientes que se encuentren en la base de datos de BENEITO FAURE y será actualizada siempre que sea necesario. Los precios no incluyen IVA ni tasa de reciclaje.

PEDIDOS

Los pedidos deberán ser enviados vía email. No se cursará ningún pedido por teléfono o cualquier otra vía. Los presupuestos de material que se deba manipular a medida se enviarán al cliente para su aceptación y no se cursaran hasta recibir la copia firmada de la aceptación.

DEVOLUCIONES

Para realizar cualquier devolución se deberá solicitar la autorización previa a BENEITO FAURE. Deberá comunicarse el motivo de la devolución vía email indicando el nombre del cliente, fecha de compra, unidades y referencia del producto devuelto, motivo de la devolución y albarán de compra. La aceptación de la devolución no implica la aceptación definitiva de ésta. Dicha devolución solo será definitiva tras la consiguiente verificación y análisis del producto por parte de nuestro departamento técnico. Solo serán aceptadas las devoluciones de mercancía si ésta se encuentra en perfecto estado para su venta y en su embalaje original en buen estado, así como la etiqueta de embalaje. Las devoluciones no serán compensadas mediante un importe económico. La devolución de material podrá ser compensada mediante un pedido previo y con la autorización de BENEITO FAURE. No se aceptarán devoluciones de productos de fabricación especial o previamente manipulados por parte del departamento técnico bajo petición del cliente.

TRANSPORTE

Salvo que se acuerden otros términos de transporte, la mercancía viajará por cuenta de los comprados con las condiciones EXWORKS. Así mismo, BENEITO FAURE ofrecerá un tiempo de entrega por cada territorio, siendo éste siempre aproximado. La empresa no se hará cargo de posibles alteraciones o demoras sobre éste tiempo producidas por causas externas a la empresa.

RESERVA DE LA PROPIEDAD

BENEITO FAURE se reserva el derecho a la propiedad de todos los materiales que suministre hasta que el comprador haya hecho efectivo el pago del total de los mismos.

Las mercancías pedidas se suministran bajo reserva de dominio en favor de BENEITO FAURE hasta el total cumplimiento de las obligaciones de pago del cliente.

El cliente queda obligado a cooperar y adoptar las medidas que sean necesarias y las que BENEITO FAURE le proponga para salvaguardar su propiedad sobre la mercancía. La reserva del dominio persiste incluso en el supuesto de que el cliente tuviera créditos aceptados y reconocidos contra BENEITO FAURE o se hubiera establecido un sistema de cuentas corrientes entre ambos. La transformación o mejora de la mercancía sobre la que BENEITO FAURE tiene reserva de dominio no otorga su propiedad al cliente o manipulador. En el supuesto de unión, transformación y/o accesión de los productos bajo la reserva de dominio a productos de terceros subsistirá la reserva de dominio en la proporción correspondiente al valor que tuvieran los productos objeto de reserva de dominio con anterioridad a la accesión. El cliente podrá vender los bienes sujetos a la reserva de dominio en el curso ordinario de sus negocios, siempre y cuando no haya incumplido sus obligaciones de pago frente a BENEITO FAURE. En todo caso al producirse una reventa de mercancías sujetas a reserva de dominio, se produce automáticamente la cesión a BENEITO FAURE de los créditos nacidos en consecuencia de dicha reventa en favor del vendedor, así como de cualesquiera otros créditos precedentes, en su caso de indemnizaciones por pérdida de la cosa, responsabilidad extracontractual, etc. El cliente estará obligado en estos supuestos a facilitar a BENEITO FAURE toda la información y documentación necesaria para la reclamación de los créditos subrogados. En caso de incumplimiento por parte del cliente, y en particular, en el supuesto de retraso en los pagos o en caso de declaración de concurso del cliente, BENEITO FAURE reclamará, previa notificación al cliente, en posesión de las mercancías, estando obligado éste a entregárselas. Si antes de efectuado el total pago del precio, las mercancías vendidas fuesen objeto de cualquier embargo o traba, el cliente vendrá obligado a hacer constar expresamente en la diligencia del embargo, que las mercancías son prioridad de BENEITO FAURE y si, a pesar de esta manifestación, fuesen embargados, facilitará el ejercicio por parte de la BENEITO FAURE de la correspondiente acción de tercería de dominio, cuyos gastos correrán por parte del cliente.

PLAZO DE ENTREGA

Los plazos y disponibilidad ofrecidos por BENEITO FAURE son siempre aproximados y pueden estar sujetos a variaciones. Éstas posibles variaciones en los plazos no supondrán la aceptación de la responsabilidad o penalizaciones por la demora por parte de BENEITO FAURE.

RECLAMACIONES

En el albarán del transportista deberá constar cualquier anomalía visible y, tras haber revisado el material, comunicar por escrito a nuestras oficinas la incidencia en las 24 horas siguientes a la recepción de la mercancía.

Superado este tiempo, la empresa no podrá hacerse cargo de la reclamación por no estar en el plazo por la agencia de transporte.

Para otro tipo de reclamaciones, deberá comunicarse por escrito a nuestras oficinas.

El producto que no funcione correctamente será repuesto por otro igual o que cumpla con las mismas características. En ningún caso nos haremos cargo de los costes de la mano de obra que se pueda originar por el mal funcionamiento de un producto de nuestro catálogo.

GARANTÍA

BENEITO FAURE garantiza que los productos que se venden se encuentran en perfecto estado. La garantía cubrirá la reparación o la reposición del producto (bajo decisión de BENEITO FAURE) y será necesario el previo envío de la incidencia por email. La garantía del producto se encuentra en el embalaje del mismo. El departamento técnico de BENEITO FAURE será el único autorizado para determinar si se trata de un defecto de fabricación, después de recibir por escrito la incidencia y la factura de venta para previa verificación. BENEITO FAURE basa el tiempo de garantía en los años desde que el producto fue comprado por el cliente, no en las horas de funcionamiento de éste.

La GARANTÍA no se cubrirá:

1. Si el producto ha sido previamente manipulado.
2. No se encuentra instalado según las instrucciones.
3. Si la ventilación del cuál no es la adecuada.
4. Problemas de pago parcial o en su totalidad por parte del cliente.

JURISDICCIÓN

En cualquier discrepancia o disputa, ambas partes se someterán a la jurisdicción de los Jueces y tribunales de Barcelona.



Numerical Index

NEWS & EVOLUTION

4142-V2	129	4606	48	4652	63
4143-V3	129	4607	48	4653	61
4230-N	135	4608	48	4654	61
4231-N	135	4609	48	4655	60
4232-N	134	4610	48	4657	63
4233-N	134	4611	48	4658	63
4241-N	128	4612	48	4659	61
4242-N	128	4613	48	4660	61
4336-N	126	4614	48	4661	61
4338-N	126	4615	48	4662	61
4441-N	125	4616	48	4663	60
4442-N	125	4617	48	4664	60
4573	58	4618	48	4665	60
4574	58	4619	48	4666	60
4575	58	4620	48	4667	139
4576	58	4621	52	4668	139
4577	58	4622	52	4669	140
4578	58	4623	52	4670	140
4579	58	4624	52	4671	147
4580	58	4625	52	4672	147
4581	58	4626	52	4677	146
4582	58	4627	52	4678	146
4583	58	4628	52	4679	142
4584	58	4629	52	4680	142
4585	58	4630	52	4681	142
4586	58	4631	52	4682	143
4587	58	4632	52	4683	143
4588	58	4633	52	4684	143
4589	50	4634	52	4685	144
4590	50	4635	52	4686	144
4591	50	4636	52	4687	144
4592	50	4637	61	4688	145
4593	50	4638	61	4689	145
4594	50	4639	60	4690	66
4595	50	4640	60	4691	136
4596	50	4641	60	4692	66
4597	50	4642	60	4693	66
4598	50	4643	61	4694	145
4599	50	4644	61	4704	80
4600	50	4645	63	4705	82
4601	50	4646	63	4707	63
4602	50	4647	60	4708	63
4603	50	4648	60	4709	138
4604	50	4649	61	4710	138
4065	48	4650	61	4711	63
		4651	63	4731	26

4732	26	15122	94	52600	106
4733	26	16119	94	57241	109
4734	26	16122	94	58242	109
4735	26	17119	92	59249	109
4736	26	17122	92	61270	105
4737	26	18119	92	61300	105
4738	26	18122	92	61400	105
4739	22	19119	96	61600	105
4740	22	19122	96	69270	102
4742	40	22410	109	69275	102
4743	42	22415	109	69300	102
4744	40	22420	109	69305	102
4745	42	22424	109	69400	102
4746	40	22432	109	69405	102
4747	42	22435	109	69600	102
4748	40	22460	109	69605	102
4749	42	31270	101	77019	108
4750	36	31300	101	78029	108
4751	36	31400	101	79430	108
4752	36	32275	107	80260	108
4753	124	32305	107	81990	108
4754	124	32405	107	84270	101
4755	70	32605	107	84275	101
4756	70	35119	97	84300	101
4757	70	36360	104	84305	101
4758	74	38119	97	84400	101
4759	74	41270	102	84405	101
4946	30	41275	102	84600	101
4947	30	41300	102	84605	101
4950	32	41305	102	86019	108
4951	32	41400	102	87029	108
4952	130	41405	102	88460	108
4953	130	41600	102	89260	108
4954	132	41605	102	90990	108
4955	132	43430	106	91430	108
4956	11	46460	103	83XXXX	114
		46465	103	93XXXX	115
		47430	103	75XXXX	116
		49270	104	55XXXX	117
		49300	104	44X99X	118
		49400	104	56XXXX	119
		49600	104		
		50460	105		
		52270	106		
		52300	106		
		52400	106		
PROFILES					
10119	96				
10122	96				
11119	93				
12119	93				
13119	95				
14119	95				
15119	94				

Name Index

ATMOS

ATMOS	130
ATMOS GU10	132
ATMOS SLIM	36

BORA

BORA RECESSED 4,5W	50
BORA RECESSED 8,5W	50
BORA MAGNET TRACK	58
BORA MAGNET TRACK SUSPENSION	58
BORA SURFACE 4,5W	52
BORA SURFACE 8,5W	52
BORA SUSPENSION RECESSED	48
BORA SUSPENSION SURFACE	48

BORA ACCESORIES

CENTRAL CORNER JOINT WITH CONNECTOR	63
END CAP RAIL	60-61
LINEAR JOIN WITHOUT SPACING	60-61
L-JOINT CEILING	60-61
L-JOINT WALL CEILING	60-61
MAGNET RAIL	60-61
PVC TRIM	63
START MAGNETIC RAIL CONNECTOR	63
POWER SUPPLIES 48V	63

CAM

CAM 60CM	138
----------	-----

CONCORD

CONCORD SWITCH	134
----------------	-----

FENIX

FENIX	80
-------	----

GLOBO

GLOBO	146
-------	-----

KOM

KOM	126
-----	-----

KONIC

KONIC	125
-------	-----

LED STRIPS

FINE-31	101
FINE-32	107
FINE-36	104
FINE-41	102
FINE-43	106
FINE-46	103
FINE-47	103
FINE-49	104
FINE-50	105
FINE-52	106
FINE-61	105
FINE-69	102
FINE-84	101

LED STRIPS ACCESORIES

CONTROL BASIC	108
CONTROL TOP	108
CONTROL CASAMBI	109
POWE SUPPLIES	109

LIEVO

LIEVO	22
-------	----

LUK

LUK	74
-----	----

LUMINARIES

TIME	114
TIME-E	115
KUBO	116
KUBO-E	117
NEXUS	118
DUAL	119

NARROW DIMMABLE

NARROW DIMMABLE	147
-----------------	-----

NOX

NOX SWITCH	128
------------	-----

PROFILES

BOX-10	96
BOX-11	93
BOX-12	93
BOX-13	95
BPX-14	95
BOX-15	94
BOX-16	94
BOX-17	92
BOX-18	92
BOX-19	96
BOX-35	97
BOX-38	97

PULCOM

PULCOM	40
PULCOM ASYMMETRIC	42

PURE

PURE	129
------	-----

ROK

ROK	70
-----	----

RUBYC

RUBYC	135
-------	-----

SELEN

SELEN	139
-------	-----

SKY SWITCH

SKY SWITCH 10W	142
SKY SWITCH 20W	143
SKY SWITCH 30W	144
SKY SWITCH 40W	145

SONO

SONO 40W	30
SONO 60W	32

THESSIS DIMMABLE

THESSIS DIMMABLE	136
------------------	-----

THREE PHASE TRACK

THREE PHASE RECESSED TRACK	124
----------------------------	-----

TOP

TOP	82
-----	----

TRAM RECESSED

TRAM RECESSED /2	26
TRAM RECESSED /5	26
TRAM RECESSED /10	26
TRAM RECESSED /15	26

TUYA ACCESORIES

GATEWAY TUYA	11
--------------	----

ZAS SQUARE

ZAS SQUARE	66
------------	----

ZIBOR

ZIBOR	140
-------	-----

HEADQUARTERS

C/ Thomas Edison 4-6
Polig. Valldoríolf
08430 La Roca del Vallès
Barcelona (Spain)

C/ Noria 10
Polig. Valldoríolf
08430 La Roca del Vallès
Barcelona (Spain)

CONTACT

beneito@beneito-faure.com
www.beneito-faure.com
T +34 935 684 045



BENEITO FAURE[®]

passion for led light

